



BLACKHAWK[®]

2022 CATALOG



IN 1990, A NAVY SEAL WAS NAVIGATING A MINEFIELD WHEN HIS PACK FAILED. AS HIS GEAR TUMBLED TO THE GROUND, HE VOWED THAT IF HE GOT OUT OF THERE ALIVE HE WOULD MAKE GEAR THE RIGHT WAY. TODAY, THIS COMMITMENT TO QUALITY AND RELIABILITY APPLIES TO EVERYTHING WE DO. WE'RE CONSTANTLY RESEARCHING, REFINING AND PERFECTING EVERY DETAIL TO PROVIDE PRODUCTS THAT WON'T LET YOU DOWN. AT BLACKHAWK, WE'RE NOT JUST MAKING GEAR; WE'RE HONORING A VOW.

 **BLACKHAWK®**



**BORN FROM
EXPERIENCE.
MADE FOR
THE MISSION.**







NEW PRODUCTS

001-004: T-SERIES NEW FITS / FOUNDATION SERIES / STACHE IWB HOLSTER / T-SERIES L2C OVERT / T-SERIES QUICK DISCONNECT / T-SERIES MOLLE ADAPTER / LEG STRAP ADAPTER / MICRO TAC HOLSTER PLATFORM / TRIDENT ELBOW & KNEE PADS / LOAD BEARING CARABINERS / KNOXX AR HANDGUARD / 2.25" DUTY BELTS

HOLSTERS

007-088: DUTY / CONCEALMENT / TACTICAL / PLATFORMS & ACCESSORIES

DUTY & PROTECTIVE GEAR

091-206: ENTRY TOOLS / PLATE CARRIERS / LEG PLATFORMS / LOAD BEARING GEAR / VESTS / POUCHES / BELTS / DUTY GEAR / ELBOW & KNEE PADS

APPAREL

209-230: HEADWEAR / FOOTWEAR / GLOVES

BAGS / PACKS / CASES

233-268: BAGS / PACKS / RANGE BAGS & GUN CASES

ACCESSORIES

271-318: SLINGS & SLING MOUNTS / LONG GUN ACCESSORIES / ON-GUN COMPONENTS / SHOOTING SUPPORT & KNIVES / MISCELLANEOUS





NEW PRODUCTS





T-SERIES NEW FITS



L2C

PAGE 28

L2D

PAGE 08

L3D

PAGE 12/13

RDS

PAGE 9/13



**T-SERIES
L2C
OVERT**

PAGE 62



**T-SERIES
MODULAR
DROP KIT**

PAGE 74



**T-SERIES
QUICK
DISCONNECT**

PAGE 74



**T-SERIES
MOLLE
ADAPTER**

PAGE 77



**LEG
STRAP
ADAPTER**

PAGE 83



**MICRO TAC
HOLSTER
PLATFORM**

PAGE 83



**STACHE
INSIDE THE
WAISTBAND**

PAGE 32



**TECGRIP
FORMLOK
MOLDABLE IWB**

PAGE 38

FOUNDATION SERIES



**PLATE CARRIER
PAGE 122**



**CHEST RIG
PAGE 136**



**PLACARD MOLLE W/ KANGAROO
PAGE 139**



**PLACARD FIRST RESPONDER
PAGE 136**



**PLATE MOLLE FLAT
PAGE 139**



**GUN BELT
PAGE 176**



**INNER BELT
PAGE 176**



**SINGLE 7.62 MAG POUCH
PAGE 152**



**DOUBLE 7.62 MAG POUCH
PAGE 152**



**FLASHBANG POUCH
PAGE 153**



**SINGLE PISTOL MAG POUCH
PAGE 154**



**DOUBLE PISTOL MAG POUCH
PAGE 154**



**SINGLE 5.56 MAG POUCH
PAGE 153**



**DOUBLE 5.56 MAG POUCH
PAGE 153**



**RADIO / GPS POUCH
PAGE 154**



**TQ W/GLOVE POUCH
PAGE 157**



**IFAK
PAGE 157**



**UTILITY POUCH
PAGE 157**



**FOLDING DUMP POUCH
PAGE 157**



**TRIDENT
ELBOW &
KNEE PADS**

PAGE 204



**LOAD
BEARING
CARABINERS**

PAGE 316



**REINFORCED
2.25" WEB
DUTY BELTS**

PAGE 186



**REINFORCED
2.25" DUTY BELT
W/LOOP**

PAGE 183



**2.25" WEB
DUTY
BELTS**

PAGE 182



**TLR1-HL & TLR7A-FLEX
WEAPON LIGHTS**

PAGE 316



**KNOXX
AR HANDGUARD**

PAGE 306



HOLSTERS



- DUTY
- CONCEALMENT
- TACTICAL
- PLATFORMS & ACCESSORIES



HOLSTERS DUTY

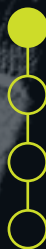

T-SERIES® L2D DUTY HOLSTER / NON LIGHT BEARING

- Thumb-activated retention utilizing Master Grip Principle
- Low-friction internal material creates a smooth, effortless draw
- Sound-dampening lining for stealthy drawing and re-holstering
- Durable polymer construction provides protection with minimal bulk
- Full-coverage design protects rear sight
- Made in the USA

PART NUMBER	GUN FIT	COLOR	SIZE	MSRP
44N100BKL	Glock 17/19/22/23/31/32/45/47, not Gen 5 .40	Black	00	\$129.95
44N100BKR	Glock 17/19/22/23/31/32/45/47, not Gen 5 .40	Black	00	\$129.95
44N161BKL	Sig P320 9/.40 ,M17/M18	Black	61	\$129.95
44N161BKR	Sig P320 9/.40 ,M17/M18	Black	61	\$129.95
44N125BKR	S&W M&P 1.0/2.0 9/.40/45	Black	25	\$129.95
44N125BKL	S&W M&P 1.0/2.0 9/.40/45	Black	25	\$129.95
44N179BKR	H&K VP9	Black	79	\$129.95
44N179BKL	H&K VP9	Black	79	\$129.95

BASKETWEAVE

44N100BWR	Glock 17/19/22/23/31/32/45/47, not Gen 5 .40	Black	00	\$149.95
44N100BWL	Glock 17/19/22/23/31/32/45/47, not Gen 5 .40	Black	00	\$149.95
44N161BWR	Sig P320 9/.40 ,M17/M18	Black	61	\$149.95
44N161BWL	Sig P320 9/.40 ,M17/M18	Black	61	\$149.95



T-SERIES® L2D DUTY HOLSTER / LIGHT BEARING

- Thumb-activated retention utilizing Master Grip Principle
- Low-friction internal material creates a smooth, effortless draw
- Sound-dampening lining for stealthy drawing and re-holstering
- Durable polymer construction provides protection with minimal bulk
- Full-coverage design protects rear sight
- Made in the USA

PART NUMBER	GUN FIT	COLOR	SIZE	MSRP
44N200BKL	Glock 17/19/22/23/31/32/47 w/TLR 1/2, not Gen 5 .40	Black	00	\$149.95
44N200BKR	Glock 17/19/22/23/31/32/47 w/TLR 1/2, not Gen 5 .40	Black	00	\$149.95
44N261BKL	Sig P320 9/.40 ,M17/M18 w/TLR 1/2	Black	61	\$149.95
44N261BKR	Sig P320 9/.40 ,M17/M18 w/TLR 1/2	Black	61	\$149.95
44N213BKL	Glock 20/21/37/38 & S&W M&P w/o Safety, SD 9/.40 w/TLR 1/2	Black	13	\$149.95
44N213BKR	Glock 20/21/37/38 & S&W M&P w/o Safety, SD 9/.40 w/TLR 1/2	Black	13	\$149.95
44N300BKR	Glock 17/19/22/23/31/32/45/47 w/TLR 7/8, not Gen 5 .40	Black	00	\$149.95
44N300BKL	Glock 17/19/22/23/31/32/45/47 w/TLR 7/8, not Gen 5 .40	Black	00	\$149.95
44N361BKR	Sig P320 9/.40 ,M17/M18 w/TLR 7/8	Black	61	\$149.95
44N361BKL	Sig P320 9/.40 ,M17/M18 w/TLR 7/8	Black	61	\$149.95
44N379BKR	H&K VP9 w/ TLR 7/8	Black	79	\$149.95
44N379BKL	H&K VP9 w/TLR 7/8	Black	79	\$149.95

BASKETWEAVE

44N200BWR	Glock 17/19/22/23/31/32/47 w/TLR 1/2, not Gen 5 .40	Black	00	\$149.95
44N200BWL	Glock 17/19/22/23/31/32/47 w/TLR 1/2, not Gen 5 .40	Black	00	\$149.95
44N300BWR	Glock 17/19/22/23/31/32/47 w/TLR 7/8, not Gen 5 .40	Black	00	\$149.95
44N300BWL	Glock 17/19/22/23/31/32/47 w/TLR 7/8, not Gen 5 .40	Black	00	\$149.95
44N261BWR	Sig P320 9/.40 ,M17/M18 w/TLR 1/2	Black	61	\$149.95
44N261BWL	Sig P320 9/.40 ,M17/M18 w/TLR 1/2	Black	61	\$149.95



T-SERIES L2D LIGHT BEARING / RDS

- Thumb-activated retention follows Master Grip Principle
- Fits Streamlight TLR 1 and 2, Surefire X300 fits coming Spring 2021
- Low-friction internal material for smooth and effortless draw
- Sound-dampening lining for stealth drawing and holstering
- Durable material provides protection with sleek design for minimal bulk
- Compatible with Trijicon RMR/SRO, Leupold Delta Point Pro, Sig Romeo1Pro, and other similar sized optics
- Additional rotating dust cover to further protect optics from impacts and debris
- Dust cover is removable if desired
- Made in the USA

PART NUMBER	GUN FIT	COLOR	SIZE	MSRP
44NB00BKR	Glock 17/19/22/23/31/32/47 w/TLR 1/2, not Gen 5 .40	Black	00	\$149.95
44NB00BKL	Glock 17/19/22/23/31/32/47 w/TLR 1/2, not Gen 5 .40	Black	00	\$149.95
44NB61BKR	Sig P320 9/.40 ,M17/M18 w/TLR 1/2	Black	61	\$149.95
44NB61BKL	Sig P320 9/.40 ,M17/M18 w/TLR 1/2	Black	61	\$149.95
44NE00BKR	Glock 17/19/22/23/31/32/47 w/TLR 7/8, not Gen 5 .40	Black	00	\$149.95
44NE00BKL	Glock 17/19/22/23/31/32/47 w/TLR 7/8, not Gen 5 .40	Black	00	\$149.95
44NA00BKR	Glock 17/19/22/23/31/32/45/47 w/X300, not Gen 5 .40	Black	00	\$149.95
44NA00BKL	Glock 17/19/22/23/31/32/45/47 w/X300, not Gen 5 .40	Black	00	\$149.95
BASKETWEAVE				
44NB00BWR	Glock 17/19/22/23/31/32/47 w/TLR 1/2, not Gen 5 .40	Black	00	\$149.95
44NB00BWL	Glock 17/19/22/23/31/32/47 w/TLR 1/2, not Gen 5 .40	Black	00	\$149.95
44NB61BWR	Sig P320 9/.40 ,M17/M18 w/TLR 1/2	Black	61	\$149.95
44NB61BWL	Sig P320 9/.40 ,M17/M18 w/TLR 1/2	Black	61	\$149.95





T-SERIES L3D DUTY HOLSTER / LIGHT BEARING

- Thumb-activated retention utilizing Master Grip Principle
- Low-friction internal material creates a smooth, effortless draw
- Sound-dampening lining for stealthy drawing and re-holstering
- Durable polymer construction provides protection with minimal bulk
- Full-coverage design protects rear sight
- Level 3 retention secures back of slide
- Made in the USA

PART NUMBER	GUN FIT	COLOR	SIZE	MSRP
44N600BKL	Glock 17/19/22/23/31/32/47 w/TLR 1/2, not Gen 5 .40	Black	00	\$169.95
44N600BKR	Glock 17/19/22/23/31/32/47 w/TLR 1/2, not Gen 5 .40	Black	00	\$169.95
44N661BKL	Sig P320 9/.40 ,M17/M18 w/TLR 1/2	Black	61	\$169.95
44N661BKR	Sig P320 9/.40 ,M17/M18 w/TLR 1/2	Black	61	\$169.95
44N613BKL	Glock 20/21/37/38 & S&W M&P w/o Safety, SD 9/.40 w/TLR 1/2	Black	13	\$169.95
44N613BKR	Glock 20/21/37/38 & S&W M&P w/o Safety, SD 9/.40 w/TLR 1/2	Black	13	\$169.95
44N700BKR	Glock 17/19/22/23/31/32/45/47 w/TLR 7/8, not Gen 5 .40	Black	00	\$169.95
44N700BKL	Glock 17/19/22/23/31/32/45/47 w/TLR 7/8, not Gen 5 .40	Black	00	\$169.95
44N761BKR	Sig P320 9/.40 ,M17/M18 w/TLR 7/8	Black	61	\$169.95
44N761BKL	Sig P320 9/.40 ,M17/M18 w/TLR 7/8	Black	61	\$169.95
44N779BKR	H&K VP9 w/ TLR 7/8	Black	79	\$169.95
44N779BKL	H&K VP9 w/TLR 7/8	Black	79	\$169.95
BASKETWEAVE				
44N600BWR	Glock 17/19/22/23/31/32/47 w/TLR 1/2, not Gen 5 .40	Black	00	\$169.95
44N600BWL	Glock 17/19/22/23/31/32/47 w/TLR 1/2, not Gen 5 .40	Black	00	\$169.95
44N661BWR	Sig P320 9/.40 ,M17/M18 w/TLR 1/2	Black	61	\$169.95
44N661BWL	Sig P320 9/.40 ,M17/M18 w/TLR 1/2	Black	61	\$169.95
44N700BWR	Glock 17/19/22/23/31/32/47 w/TLR 7/8, not Gen 5 .40	Black	00	\$169.95
44N700BWL	Glock 17/19/22/23/31/32/47 w/TLR 7/8, not Gen 5 .40	Black	00	\$169.95



T-SERIES L3D DUTY HOLSTER / NON LIGHT BEARING

- Thumb-activated retention utilizing Master Grip Principle
- Low-friction internal material creates a smooth, effortless draw
- Sound-dampening lining for stealthy drawing and re-holstering
- Durable polymer construction provides protection with minimal bulk
- Full-coverage design protects rear sight
- Level 3 retention secures back of slide
- Made in the USA

PART NUMBER	GUN FIT	COLOR	SIZE	MSRP
44N500BKL	Glock 17/19/22/23/31/32/45/47, not Gen 5 .40	Black	00	\$149.95
44N500BKR	Glock 17/19/22/23/31/32/45/47, not Gen 5 .40	Black	00	\$149.95
44N561BKL	Sig P320 9/.40 ,M17/M18	Black	61	\$149.95
44N561BKR	Sig P320 9/.40 ,M17/M18	Black	61	\$149.95
44N525BKR	S&W M&P 1.0/2.0 9/.40/45	Black	25	\$149.95
44N525BKL	S&W M&P 1.0/2.0 9/.40/45	Black	25	\$149.95
44N579BKR	H&K VP9	Black	79	\$149.95
44N579BKL	H&K VP9	Black	79	\$149.95
BASKETWEAVE				
44N500BWR	Glock 17/19/22/23/31/32/45/47, not Gen 5 .40	Black	00	\$169.95
44N500BWL	Glock 17/19/22/23/31/32/45/47, not Gen 5 .40	Black	00	\$169.95
44N561BWR	Sig P320 9/.40 ,M17/M18	Black	61	\$169.95
44N561BWL	Sig P320 9/.40 ,M17/M18	Black	61	\$169.95



T-SERIES L3D LIGHT BEARING / RDS

- Thumb-activated retention follows Master Grip Principle
- Fits Streamlight TLR 1 and 2, Surfire X300 fits coming Spring 2021
- Low-friction internal material for smooth and effortless draw
- Sound-dampening lining for stealth drawing and holstering
- Durable material provides protection with sleek design for minimal bulk
- Level 3 adds retention strap over back of slide
- Compatible with Trijicon RMR/SRO, Leupold Delta Point Pro, Sig Romeo1Pro, and other similar sized optics
- Additional rotating dust cover to further protect optics from impacts and debris
- Dust cover is removable if desired
- Made in the USA

PART NUMBER	GUN FIT	COLOR	SIZE	MSRP
44ND00BKR	Glock 17/19/22/23/31/32/47 w/TLR 1/2, not Gen 5 .40	Black	00	\$169.95
44ND00BKL	Glock 17/19/22/23/31/32/47 w/TLR 1/2, not Gen 5 .40	Black	00	\$169.95
44ND61BKR	Sig P320 9/.40 ,M17/M18 w/TLR 1/2	Black	61	\$169.95
44ND61BKL	Sig P320 9/.40 ,M17/M18 w/TLR 1/2	Black	61	\$169.95
44NF00BKR	Glock 17/19/22/23/31/32/47 w/TLR 7/8, not Gen 5 .40	Black	00	\$169.95
44NF00BKL	Glock 17/19/22/23/31/32/47 w/TLR 7/8, not Gen 5 .40	Black	00	\$169.95
44NC00BKR	Glock 17/19/22/23/31/32/45/47 w/X300, not Gen 5 .40	Black	00	\$169.95
44NC00BKL	Glock 17/19/22/23/31/32/45/47 w/X300, not Gen 5 .40	Black	00	\$169.95
BASKETWEAVE				
44ND00BWR	Glock 17/19/22/23/31/32/47 w/TLR 1/2, not Gen 5 .40	Black	00	\$169.95
44ND00BWL	Glock 17/19/22/23/31/32/47 w/TLR 1/2, not Gen 5 .40	Black	00	\$169.95
44ND61BWR	Sig P320 9/.40 ,M17/M18 w/TLR 1/2	Black	61	\$169.95
44ND61BWL	Sig P320 9/.40 ,M17/M18 w/TLR 1/2	Black	61	\$169.95







SERPA® LEVEL 2 AUTO LOCK™ DUTY HOLSTER

- SERPA® Auto Lock™ release
- Passive retention detent adjustment screw
- Full-length holster body protects rear sights
- Includes unique SERPA® Jacket Slot Belt Loop to attach to belt without unthreading other gear
- Mid-Ride Duty Belt Loop and High-Ride Duty Belt Loop also available (sold separately)
- Fits all Blackhawk injection-molded platforms
- Made in the USA

SERPA® LEVEL 2 AUTO LOCK™ DUTY HOLSTER

PART NUMBER	GUN FIT	COLOR	SIZE	MSRP	MTO
44H000BK-L	Glock 17/19/20/21/22/23/31/32/45, not gen 5 .40 & S&W M&P 9/.40/.45	00	Black	\$89.95	
44H000BK-R	Glock 17/19/22/23/31/32/45, not gen 5 .40	00	Black	\$89.95	
44H003BK-R	Colt 1911 Gov't & Clones w/ or w/o rail, Not all clones	03	Black	\$89.95	
44H004BK-L	Beretta 92/96/M9 (Not Elite, Brig., or M9A1)	04	Black	\$89.95	MTO
44H004BK-R	Beretta 92/96/M9 (Not Elite, Brig., or M9A1)	04	Black	\$89.95	
44H006BK-L	Sig 220/225/226/228/229, MK25 w/ or w/o rail (not ES)	06	Black	\$89.95	
44H006BK-R	Sig 220/225/226/228/229, MK25 w/ or w/o rail (not ES)	06	Black	\$89.95	
44H008BK-R	Sig Pro 2022	08	Black	\$89.95	MTO
44H013BK-R	Glock 20/21/21SF (not 1913 Rail)/37/38 & S&W M&P 9/.40/.45	13	Black	\$89.95	
44H026BK-R	Glock 21SF w/1913 Rail	26	Black	\$89.95	
44H061BKL	Sig P320/P250 (not sub compact or P320 .45)	61	Black	\$89.95	
44H061BKR	Sig P320/P250 (not sub compact or P320 .45)	61	Black	\$89.95	

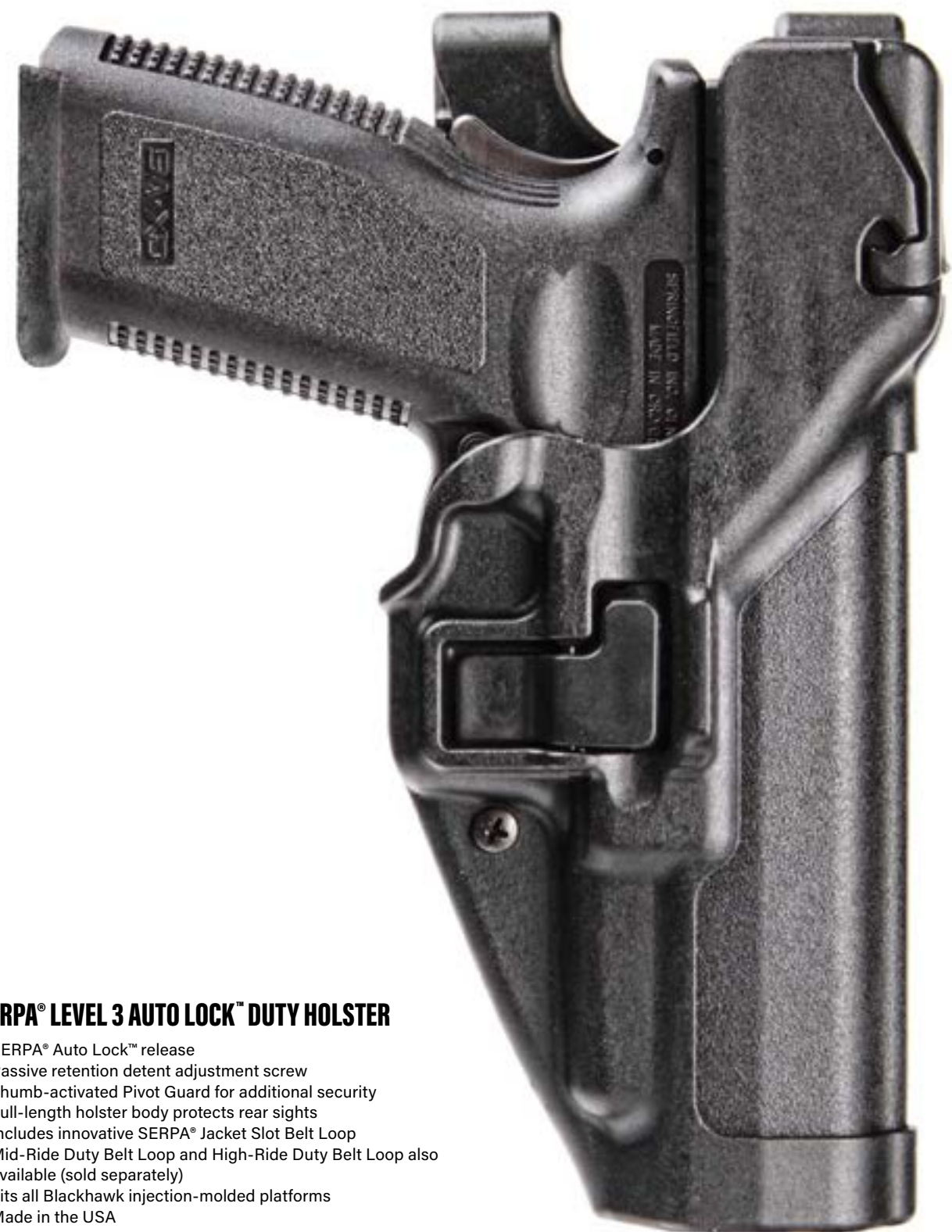

SERPA® LEVEL 3 AUTO LOCK™ DUTY HOLSTER

- SERPA® Auto Lock™ release
- Passive retention detent adjustment screw
- Thumb-activated Pivot Guard for additional security
- Full-length holster body protects rear sights
- Includes innovative SERPA® Jacket Slot Belt Loop
- Mid-Ride Duty Belt Loop and High-Ride Duty Belt Loop also available (sold separately)
- Fits all Blackhawk injection-molded platforms
- Made in the USA

SERPA® LEVEL 3 AUTO LOCK™ DUTY HOLSTER

PART NUMBER	GUN FIT	SIZE	FINISH	COLOR	MSRP	MTO
44H100BK-L	Glock 17/19/22/23/31/32/45/47, not Gen 5 .40	00	Matte	Black	\$113.95	
44H100BK-R	Glock 17/19/22/23/31/32/45/47, not Gen 5 .40	00	Matte	Black	\$113.95	
44H100BW-L	Glock 17/19/22/23/31/32/45/47, not Gen 5 .40	00	Basketweave	Black	\$127.95	
44H100BW-R	Glock 17/19/22/23/31/32/45/47, not Gen 5 .40	00	Basketweave	Black	\$127.95	
44H103BK-L	Colt 1911 Gov't & Clones w/ or w/o rail, not all clones	03	Matte	Black	\$113.95	MTO
44H103BK-R	Colt 1911 Gov't & Clones w/ or w/o rail, not all clones	03	Matte	Black	\$113.95	
44H103BW-L	Colt 1911 Gov't & Clones w/ or w/o rail, not all clones	03	Basketweave	Black	\$127.95	
44H104BK-L	Beretta 92/96/M9 (Not Elite, Brig., or M9A1)	04	Basketweave	Black	\$113.95	
44H104BK-R	Beretta 92/96/M9 (Not Elite, Brig., or M9A1)	04	Matte	Black	\$113.95	
44H104BW-L	Beretta 92/96/M9 (Not Elite, Brig., or M9A1)	04	Basketweave	Black	\$127.95	
44H106BK-L	Sig 220/225/226/228/229, MK25 w/ or w/o rail (not ES)	06	Matte	Black	\$113.95	
44H106BK-R	Sig 220/225/226/228/229, MK25 w/ or w/o rail (not ES)	06	Matte	Black	\$113.95	
44H106BW-L	Sig 220/225/226/228/229, MK25 w/ or w/o rail (not ES)	06	Basketweave	Black	\$127.95	
44H106BW-R	Sig 220/225/226/228/229, MK25 w/ or w/o rail (not ES)	06	Basketweave	Black	\$127.95	
44H107BK-L	Springfield XD/Mod.2/XDM 3.8"-4"	07	Matte	Black	\$113.95	
44H107BK-R	Springfield XD/Mod.2/XDM 3.8"-4"	07	Matte	Black	\$113.95	
44H107BW-L	Springfield XD/Mod.2/XDM 3.8"-4"	07	Basketweave	Black	\$127.95	
44H108BK-L	Sig Pro 2022	08	Matte	Black	\$113.95	MTO
44H108BK-R	Sig Pro 2022	08	Matte	Black	\$113.95	
44H109BK-L	H&K USP Compact / P2000 (EURO) 9/.40	09	Matte	Black	\$113.95	MTO
44H109BW-L	H&K USP Compact / P2000 (EURO) 9/.40	09	Basketweave	Black	\$127.95	MTO
44H109BK-R	H&K USP Compact / P2000 (EURO) 9/.40	09	Basketweave	Black	\$127.95	MTO
44H113BK-L	Glock 20/21/21SF (not 1913 Rail)/37/38	13	Matte	Black	\$113.95	
44H113BK-R	Glock 20/21/21SF (not 1913 Rail)/37/38	13	Matte	Black	\$113.95	
44H113BW-L	Glock 20/21/21SF (not 1913 Rail)/37/38	13	Basketweave	Black	\$127.95	
44H113BW-R	Glock 20/21/21SF (not 1913 Rail)/37/38	13	Basketweave	Black	\$127.95	
44H114BK-L	H&K USP Full Size 9/.40	14	Matte	Black	\$113.95	MTO
44H114BK-R	H&K USP Full Size 9/.40	14	Matte	Black	\$113.95	
44H114ODL	H&K USP Full Size 9/.40	14	Matte	Olive Drab	\$113.95	MTO
44H114ODR	H&K USP Full Size 9/.40	14	Matte	Olive Drab	\$113.95	MTO
44H116BK-L	H&K P2000 (Not P2000SK)	16	Matte	Black	\$113.95	MTO
44H116BK-R	H&K P2000 (Not P2000SK)	16	Matte	Black	\$113.95	
44H117BK-L	H&K P30 (not P30SK)	17	Matte	Black	\$113.95	MTO
44H117BK-R	H&K P30 (not P30SK)	17	Matte	Black	\$113.95	
44H117BW-L	H&K P30 (not P30SK)	17	Basketweave	Black	\$127.95	MTO
44H117BW-R	H&K P30 (not P30SK)	17	Basketweave	Black	\$127.95	MTO
44H124BK-R	Walther P99/ S&W SW99	24	Matte	Black	\$113.95	
44H125BK-L	S&W M&P 9/.357 Sig/.40 & SD9/40 (not CORE)	25	Matte	Black	\$113.95	
44H125BK-R	S&W M&P 9/.357 Sig/.40 & SD9/40 (not CORE)	25	Matte	Black	\$113.95	
44H125BW-L	S&W M&P 9/.357 Sig/.40 & SD9/40 (not CORE)	25	Basketweave	Black	\$127.95	
44H125BW-R	S&W M&P 9/.357 Sig/.40 & SD9/40 (not CORE)	25	Basketweave	Black	\$127.95	
44H145BK-L	S&W M&P .45 & 9/.40 Pro w/o Thumb Safety	45	Matte	Black	\$113.95	
44H145BK-R	S&W M&P .45 & 9/.40 Pro w/o Thumb Safety	45	Matte	Black	\$113.95	
44H145BW-L	S&W M&P .45 & 9/.40 Pro w/o Thumb Safety	45	Basketweave	Black	\$127.95	
44H145BW-R	S&W M&P .45 & 9/.40 Pro w/o Thumb Safety	45	Basketweave	Black	\$127.95	
44H161BK-L	Sig P320/P250	61	Matte	Black	\$113.95	
44H161BK-R	Sig P320/P250	61	Matte	Black	\$113.95	
44H161BW-L	Sig P320/P250	61	Basketweave	Black	\$127.95	
44H161BW-R	Sig P320/P250	61	Basketweave	Black	\$127.95	
44H169BK-L	Glock 34/35/41	69	Matte	Black	\$113.95	MTO
44H169BK-R	Glock 34/35/41	69	Matte	Black	\$113.95	MTO
44H169BW-L	Glock 34/35/41	69	Basketweave	Black	\$127.95	MTO
44H169BW-R	Glock 34/35/41	69	Basketweave	Black	\$127.95	MTO
44H179BK-L	H&K VP9	79	Matte	Black	\$113.95	
44H179BK-R	H&K VP9	79	Matte	Black	\$113.95	
44H180BK-L	H&K VP40	80	Matte	Black	\$113.95	MTO
44H180BK-R	H&K VP40	80	Matte	Black	\$113.95	MTO
44H180BW-L	H&K VP40	80	Basketweave	Black	\$127.95	MTO
44H180BW-R	H&K VP40	80	Basketweave	Black	\$127.95	MTO



EPOCH LEVEL 3 LIGHT BEARING

- Passive retention detent screw
- Epoch™ Auto Lock thumb release (patent pending)
- Thumb-activated Pivot Guard and Ejection-Port Lock
- Fits popular lights (TLR-1®, TLR-2®, X300)
- Reinforces full master grip
- No snaps or hoods to accidentally open
- Includes innovative Jacket Slot Duty Belt Loop
- Mid-Ride Duty Belt Loop and High-Ride Duty Belt Loop also available (sold separately)
- Fits all Blackhawk injection-molded platforms
- Made in the USA

PART NUMBER	GUN FIT	SIZE	FINISH	COLOR	MSRP	MTO
44E000BK-L	Glock 17/22/31, not Gen 5 .40	00	Matte	Black	113.95	
44E000BK-R	Glock 17/22/31, not Gen 5 .40	00	Matte	Black	113.95	
44E000BW-L	Glock 17/22/31, not Gen 5 .40	00	Basketweave	Black	127.95	
44E000BW-R	Glock 17/22/31, not Gen 5 .40	00	Basketweave	Black	127.95	
44E013BK-L	Glock 20/21/37	13	Matte	Black	113.95	
44E013BK-R	Glock 20/21/37	13	Matte	Black	113.95	
44E013BW-R	Glock 20/21/37	13	Basketweave	Black	127.95	
44E025BK-L	S&W M&P 9/.357 Sig/.40, not M&P 2.0	25	Matte	Black	113.95	
44E025BK-R	S&W M&P 9/.357 Sig/.40, not M&P 2.0	25	Matte	Black	113.95	
44E025BW-L	S&W M&P 9/.357 Sig/.40, not M&P 2.0	25	Basketweave	Black	127.95	
44E025BW-R	S&W M&P 9/.357 Sig/.40, not M&P 2.0	25	Basketweave	Black	127.95	
44E045BK-R	S&W M&P .45, not M&P 2.0	45	Matte	Black	113.95	MTO
44E045BK-L	S&W M&P .45, not M&P 2.0	45	Matte	Black	113.95	MTO
44E045BW-R	S&W M&P .45, not M&P 2.0	45	Basketweave	Black	127.95	MTO
44E045BW-L	S&W M&P .45, not M&P 2.0	45	Basketweave	Black	127.95	MTO
44E061BK-L	Sig P320/P250/M17/M18	61	Matte	Black	113.95	
44E061BK-R	Sig P320/P250/M17/M18	61	Matte	Black	113.95	
44E061BW-L	Sig P320/P250/M17/M18	61	Basketweave	Black	127.95	
44E061BW-R	Sig P320/P250/M17/M18	61	Basketweave	Black	127.95	





KILL BAD DUDES

ME.

COLBERT

WA



TASER 7 LEVEL 2 HOLSTER

- Active retention system designed for TASERS with cross draw or offside hand draw design
- Different draw motion than your pistol to help prevent confusion under stress
- When TASER is re-holstered the safety is automatically engaged.
- Holster is compatible with all Blackhawk Duty belt loops, MOLLE and tactical thigh platforms
- QDR belt loop design allows exchange between officers without removing other gear
- Trigger completely covered when holstered
- Made in the USA

PART NUMBER	DESCRIPTION	FIT	COLOR	MSRP
44HT03BKR	Taser® 7 Level 2 Duty Holster Matte	Taser 7	Black	\$54.95
44HT03BKL	Taser® 7 Level 2 Duty Holster Matte	Taser 7	Black	\$54.95



TASER® SIDE MOUNT PLATE

- Mounts the TASER® X26 Cartridge Holder to TASER® X26 Duty Holster and saves space
- Unique front side positioning allows for fast reloads
- Perfect for mounting on a crowded MOLLE vest
- Fits duty belts up to 2.25" wide
- Positions spare cartridge to outboard side of TASER® X26 Duty Holster (sold separately)
- Made in the USA

PART NUMBER	DESCRIPTION	COLOR	MSRP
44H907BK-L	TASER® X26 Side Mount Plate	Black	\$13.95
44H907BK-R	TASER® X26 Side Mount Plate	Black	\$13.95



TASER® X26/X26P, X2 LEVEL 2 HOLSTER

- Automatically engages the safety when re-holstering
- Holster bottom is configured to block the probes in case of accidental activation
- Trigger and trigger guard are completely enclosed inside holster
- Carries TASER® X26/X26P, X2 with optional camera unit attached
- Extended coverage protects polycarbonate digital readout window
- Belt loop fits most duty belts
- Rigid holster body delivers improved retention
- Protects cartridge in holster
- Designed to hold the TASER® X26 Cartridge Holder (sold separately)
- Made in the USA

PART NUMBER	DESCRIPTION	FIT	COLOR	MSRP
44H015BK-L	Taser® X26 Level 2 Duty Holster Matte	Taser X26	Black	\$51.95
44H015BK-R	Taser® X26 Level 2 Duty Holster Matte	Taser X26	Black	\$51.95
44H015BW-L	Taser® X26 Level 2 Duty Holster Basketweave	Taser X26	Black	\$64.45
44H015BW-R	Taser® X26 Level 2 Duty Holster Basketweave	Taser X26	Black	\$64.45
44HT00BK-L	Taser® X26P Level 2 Duty Holster Matte	Taser X26P	Black	\$51.95
44HT00BK-R	Taser® X26P Level 2 Duty Holster Matte	Taser X26P	Black	\$51.95
44HT01BK-R	Taser® X2 Level 2 Duty Holster Matte	Taser X-2	Black	\$51.95
44HT01BK-L	Taser® X2 Level 2 Duty Holster Matte	Taser X-2	Black	\$51.95



TASER® X26/X26P CARTRIDGE HOLDER

- Attaches easily to Blackhawk TASER® X26 Duty Holster
- Rapid reload capability
- Mini Mod-U-Lok™ belt loop with adjustable spacer fits most duty belts
- Ambidextrous design
- Made in the USA

PART NUMBER	DESCRIPTION	COLOR	MSRP
44A890BK	TASER® X26 Cartridge Holder	Black	\$25.95



HOLSTERS CONCEALMENT



T-SERIES® L2C CONCEALMENT HOLSTER / NON LIGHT BEARING

- Worlds first ever duty strength concealment holster
- Thumb-activated retention utilizing Master Grip Principle
- Low-friction internal material creates a smooth, effortless draw
- Sound-dampening lining for stealthy drawing and re-holstering
- Durable polymer construction provides protection with minimal bulk
- Low-profile design compatible with slide-mounted red-dot optics
- Speed-cut design for rapid draw, target acquisition, and re-holster
- Includes 2-Slot Belt Mount for reduced visible printing

PART NUMBER	GUN FIT	COLOR	SIZE	MSRP
410700BKL	Glock 17/22/31/34/35/41/47, not Gen 5 .40	Black	00	\$64.95
410700BKR	Glock 17/22/31/34/35/41/47, not Gen 5 .40	Black	01	\$64.95
410701BKR	Glock 19/23/26/27/32/33/45, not Gen 5 .40	Black	01	\$64.95
410757BKR	S&W M&P 9/.40/.45, SD9/.40 & Taurus PT 24/7 Pro	Black	57	\$64.95
410759BKR	S&W M&P Shield 9/.40	Black	59	\$64.95
410761ABKR	Sig P320 9/.40 ,M17/M18	Black	61	\$64.95
410761BKL	Sig P320 9/.40 ,M17/M18	Black	68	\$64.95
410768BKR	Glock 43/43X & Kahr PM9/PM40	Black	68	\$64.95
410770BKR	Sig P365/P365XL	Black	70	\$64.95
410776BKR	Glock 48	Black	76	\$64.95
410777BKR	Springfield Hellcat 9	Black	77	\$64.95
410713BKR	Glock 20/21/37/38	Black	13	\$64.95
410707BKR	Springfield XD/XDM/Mod2	Black	07	\$64.95
410703BKR	Colt 1911 w or w/o Rail-not all clones	Black	03	\$64.95
410779BKR	H&K VP9	Black	79	\$64.95
410779BKL	H&K VP9	Black	79	\$64.95
410758BKR	Ruger 57	Black	58	\$64.95



T-SERIES® L2C CONCEALMENT HOLSTER / LIGHT BEARING

- Worlds first ever duty strength concealment holster
- Thumb-activated retention utilizing Master Grip Principle
- Low-friction internal material creates a smooth, effortless draw
- Sound-dampening lining for stealthy drawing and re-holstering
- Durable polymer construction provides protection with minimal bulk
- Low-profile design compatible with slide-mounted red-dot optics
- Speed-cut design for rapid draw, target acquisition, and re-holster
- Includes 2-Slot Belt Mount for reduced visible printing

PART NUMBER	GUN FIT	COLOR	SIZE	MSRP
410200BKR	Glock 17/19/22/23/31/32/45/47 w TLR 7/8, not Gen 5 .40	Black	00	\$64.95
410200BKL	Glock 17/19/22/23/31/32/45/47 w TLR 7/8, not Gen 5 .40	Black	00	\$64.95
410261BKR	Sig P320 9/.40 ,M17/M18 w/TLR 7/8	Black	61	\$64.95
410400BKR	Glock 17/19/22/23/31/32/45/47 w/X300, not Gen 5 .40	Black	00	\$64.95
410400BKL	Glock 17/19/22/23/31/32/45/47 w/X300, not Gen 5 .40	Black	00	\$64.95

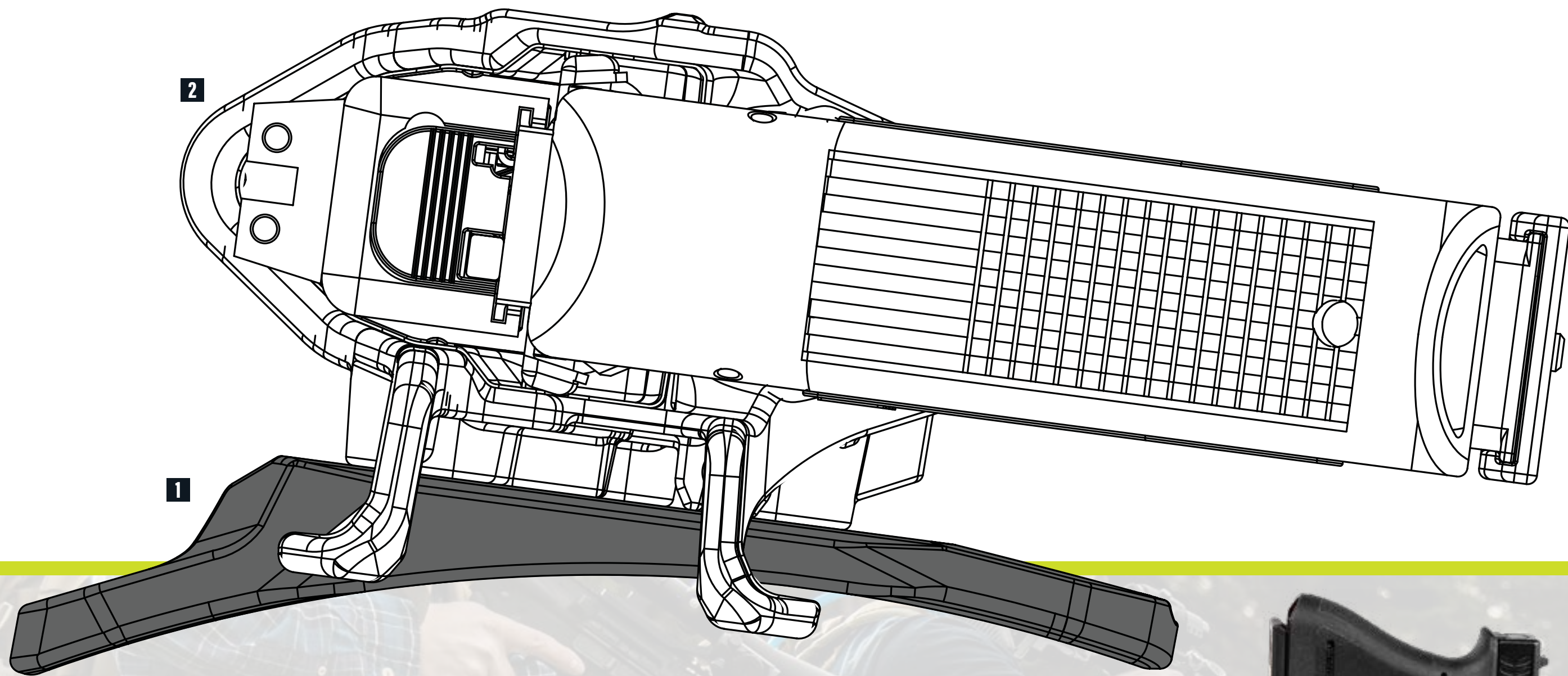

T-SERIES® L2C CONCEALMENT HOLSTER

- 2-slot belt loop cants the butt of the gun into the body on the L2C
- 2-slot belt loop also works with the Serpa CQC to improve concealment



1 2 SLOT BELT LOOP



2 T-SERIES L2C

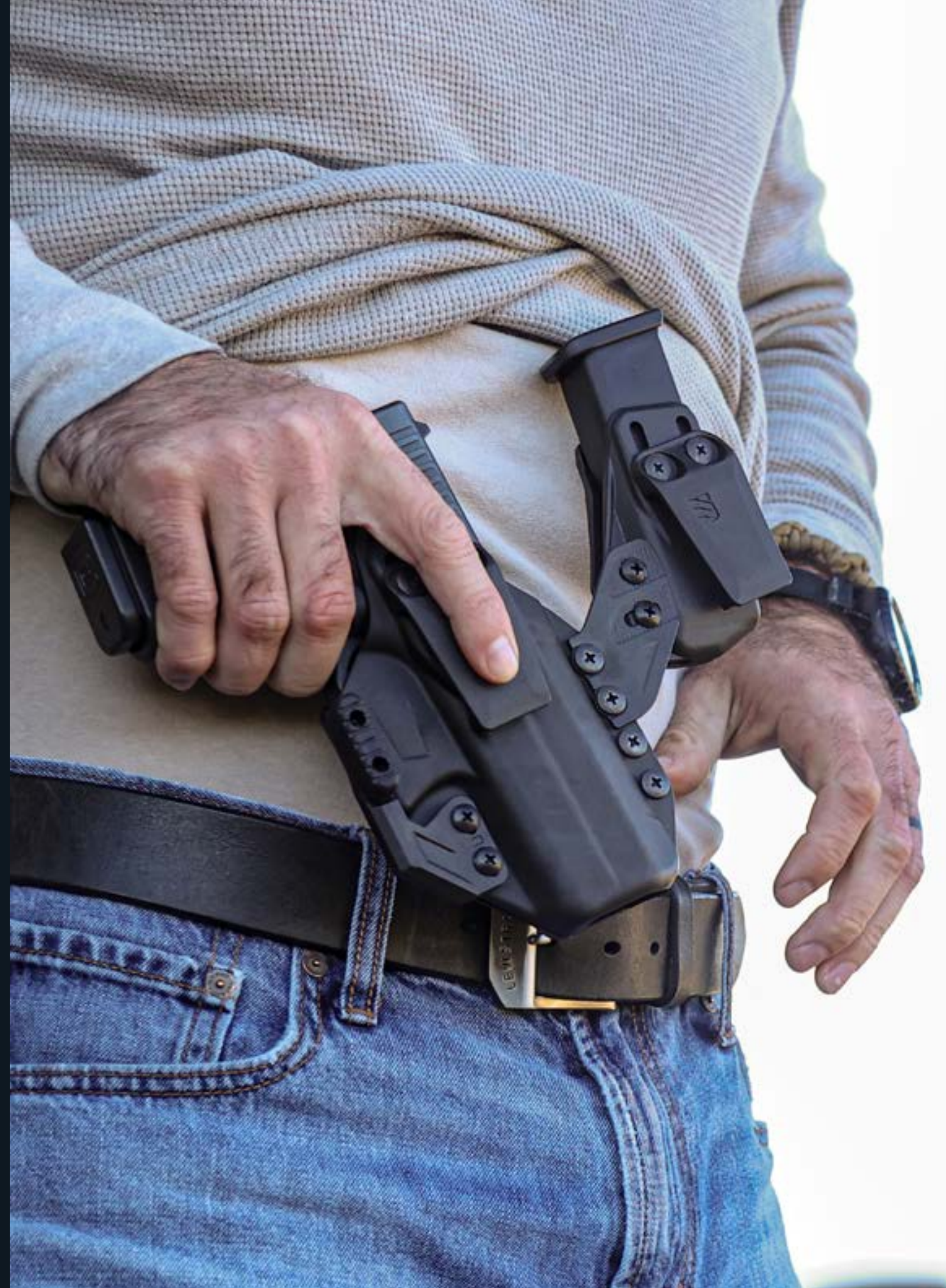

STACHE INSIDE THE WAISTBAND BASE KIT

- Injection molded polymer design
- 1.5" J-Style belt clip adjustable for height & cant
- Ambidextrous, adaptable for right or left hand carry
- Low profile shirt guard adds comfort without inhibiting draw stroke
- Can easily be adapted into several modular configurations or carry positions
- Designed to accept most popular handgun mounted RDS optics
- Compatible with an assortment of Stache™ IWB carry accessories
- Designed to accept popular Discreet Carry Concepts Gear Clips™
- Made in the USA

PART NUMBER	GUN FIT	SIZE	COLOR	MSRP
416000BK	Glock 17/22/31/47, not Gen 5 .40	00	Black	\$39.95
416001BK	Glock 26/27/33	01	Black	\$39.95
416002BK	Glock 19/23/32/45, not Gen 5 .40	02	Black	\$39.95
416003BK	Colt Govt 5" 1911 and some clones	03	Black	\$39.95
416025BK	S&W M&P 9/.40	25	Black	\$39.95
416031BK	Springfield XD 4" Compact	31	Black	\$39.95
416042BK	Colt 1911 Commander 4" & clones	42	Black	\$39.95
416049BK	Ruger EC9/LC9/LC380	49	Black	\$39.95
416061BK	Sig P320/M17	61	Black	\$39.95
416063BK	S&W M&P Shield 9/40	63	Black	\$39.95
416066BK	Sig P320 Compact/Carry/XCarry/M18	66	Black	\$39.95
416068BK	Glock 43/43x/Hellcat	68	Black	\$39.95
416070BK	Sig P365	70	Black	\$39.95
416076BK	Glock 48/M&P Shield EZ 9	76	Black	\$39.95
416078BK	Sig P365XL	78	Black	\$39.95
416079BK	H&K VP9/VP9SK	79	Black	\$39.95
416083BK	Taurus Millennium G2C	83	Black	\$39.95
416085BK	Ruger MAX-9	85	Black	\$39.95
416086BK	FN 509 Compact/Midsize	86	Black	\$39.95
416087BK	Taurus GX4	87	Black	\$39.95
416200BK	Glock 17/19/22/23/45 w/X300, not Gen 5 40	00	Black	\$39.95
416302BK	Glock 19/23/32/45 w/TLR 7/8, not Gen 5 40	02	Black	\$39.95
416366BK	Sig P320 Comp/Carry/XCarry/M18 w/TLR7/8	66	Black	\$39.95
416476BK	Glock 43x/48 w/SF XSC	76	Black	\$39.95
416563BK	S&W M&P Shield 9/40 w/CT laser	63	Black	\$39.95
416570BK	Sig P365/P365XL w/TLR-6	70	Black	\$39.95



STACHE INSIDE THE WAISTBAND PREMIUM KIT

- Injection molded polymer design
- 1.5" J-Style belt clip adjustable for height & cant
- Ambidextrous, adaptable for right or left hand carry
- Low profile shirt guard adds comfort without inhibiting draw stroke
- Can easily be adapted into several modular configurations or carry positions
- Designed to accept most popular handgun mounted RDS optics
- Compatible with an assortment of Stache™ IWB carry accessories
- Designed to accept popular Discreet Carry Concepts Gear Clips™
- Adjustable concealment claw included to reduce printing
- Includes adjustable inside the waistband magazine carrier with belt clip
- Accessory attachment wing for joining holster and mag carrier into platform
- Made in the USA

PART NUMBER	GUN FIT	SIZE	COLOR	MSRP
416100BK	Glock 17/22/31	00	Black	\$64.95
416101BK	Glock 26/27/33	01	Black	\$64.95
416102BK	Glock 19/23/32/44/45	02	Black	\$64.95
416103BK	Colt Govt 5" 1911 and some clones	03	Black	\$64.95
416125BK	S&W M&P 9/.40	25	Black	\$64.95
416131BK	Springfield XD 4" Compact	31	Black	\$64.95
416142BK	Colt 1911 Commander 4" & clones	42	Black	\$64.95
416149BK	Ruger EC9/LC9/LC380	49	Black	\$64.95
416161BK	Sig P320/M17	61	Black	\$64.95
416163BK	S&W M&P Shield 9/40	63	Black	\$64.95
416166BK	Sig P320 Compact/Carry/XCarry/M18	66	Black	\$64.95
416168BK	Glock 43/43x/Hellcat	68	Black	\$64.95
416170BK	Sig P365	70	Black	\$64.95
416176BK	Glock 48	76	Black	\$64.95
416178BK	Sig P365XL	78	Black	\$64.95
416179BK	H&K VP9/VP9SK	79	Black	\$64.95
416181BK	M&P Shield EZ 9	81	Black	\$64.95
416183BK	Taurus Millennium G2C	83	Black	\$64.95
416185BK	Ruger MAX-9	85	Black	\$64.95
416186BK	FN 509 Compact/Midsize	86	Black	\$64.95
416187BK	Taurus GX4	87	Black	\$64.95
416600BK	Glock 17/19/22/23/45 w/X300	00	Black	\$64.95
416702BK	Glock 19/23/32/45 w/TLR 7/8	02	Black	\$64.95
416766BK	Sig P320 Comp/Carry/XCarry/M18 w/TLR7/8	66	Black	\$64.95
416876BK	Glock 43x/48 w/SF XSC	76	Black	\$64.95
416963BK	S&W M&P Shield 9/40 w/CT laser	63	Black	\$64.95
416970BK	Sig P365/P365XL w/TLR-6	70	Black	\$64.95



ACCESSORIES

PART NUMBER	DESCRIPTION	COLOR	MSRP
416A00BK	Concealment Claw Kit L/R	Black	\$14.95
416A01BK	Belt Clip 1.5"	Black	\$8.95
416A02BK	Mag Carrier Double Stack	Black	\$24.95
416A03BK	Mag Carrier Single Stack	Black	\$24.95
416A05BK	Mag Carrier Micro Compact	Black	\$24.95
416A06BK	Discreet Carry Clip Compatibility Kit	Black	\$8.95
416A07BK	Stache OWB 2-Slot Belt Loop / BK Stache OWB 2-Slot Belt Loop, Bag	Black	\$14.95
416A08BK	Stache IWB Belt Clip / Non-Tuckable 1.75" BK, Bag	Black	\$8.95
416A09BK	Stache IWB Belt Clip / Tuckable 1.5" BK, Bag	Black	\$8.95
416A10BK	Stache IWB Belt Clip / Tuckable 1.75" BK, Bag	Black	\$8.95



STACHE NACHO Belly Band

- Constructed of heavy duty, double-ply 4" tall elastic band
- Belly Band secures via hook and loop closure
- Adaptive carry from Appendix, Hip, Behind Hip and Upper Torso carry
- Available in five sizes from Extra Small to Extra Large



PART NUMBER	DESCRIPTION	GUN FIT	COLOR	MSRP
60SB00BK	Stache NACHO BK Non	Cvtl-Adpt-Cry-Hlst-Opt XS 24"-29", Bag	Black	\$44.95
60SB01BK	Stache NACHO BK Non	Cvtl-Adpt-Cry-Hlst-Opt S 29"-34", Bag	Black	\$44.95
60SB02BK	Stache NACHO BK Non	Cvtl-Adpt-Cry-Hlst-Opt M 34"-39", Bag	Black	\$44.95
60SB03BK	Stache NACHO BK Non	Cvtl-Adpt-Cry-Hlst-Opt L 39"-44", Bag	Black	\$44.95
60SB04BK	Stache NACHO BK Non	Cvtl-Adpt-Cry-Hlst-Opt XL 44"-49", Bag	Black	\$44.95



STACHE RAHC Belt Pack

- Constructed of lightweight, 200D water resistant polyester
- Ambidextrous design, utilizing "V" shaped 1.5" double-layer scuba webbing
- Rapid access achieved by pulling up on bottom of storage compartment, held in place by rare earth magnets

PART NUMBER	DESCRIPTION	GUN FIT	COLOR	MSRP
60SF01BL	Stache RAHC Belt Pack Blue	Rapid-Access-Holster-Carrier, Bag	Blue	\$89.95





TecGrip FormLok Moldable IWB

- Constructed with moldable Memory-Lok® technology, allowing the user to mold the holster around their specific handgun and achieve passive (friction) retention
- Tacky exterior material clings to body and fabric, providing no-clip inside the waistband carry
- Robust interior liner constructed of rugged, friction resistant 600 denier polyester to promote long service life and inhibit friction related wear and tear
- Optic compatible, utilizing low-cut sight-track geometry
- Ambidextrous, with low profile shirt guard, optimizing end-user flexibility and comfort
- Comes with A) T-Handle molding tool, for use in forming holster around gun, and B) Heavy-mil "dunk bag" for use in heating holster to optimal thermoform temperature range.

PART NUMBER	DESCRIPTION	FIT	COLOR	MSRP
40LP01BK	TecGrip FormLok IWB BK	Moldable Holster, Ambi Size 01, Box	Black	\$54.95
40LP03BK	TecGrip FormLok IWB BK	Moldable Holster, Ambi Size 03, Box	Black	\$54.95
40LP05BK	TecGrip FormLok IWB BK	Moldable Holster, Ambi Size 05, Box	Black	\$54.95
40LP06BK	TecGrip FormLok IWB BK	Moldable Holster, Ambi Size 06, Box	Black	\$54.95
40LP07BK	TecGrip FormLok IWB BK	Moldable Holster, Ambi Size 07, Box	Black	\$54.95
40LP08BK	TecGrip FormLok IWB BK	Moldable Holster, Ambi Size 08, Box	Black	\$54.95



Sizing Chart

HANDGUN TYPE	EXAMPLE	SIZE
Small Carry Revolver	S&W J-Frame, S&W Bodyguard 38, Ruger LCR, Taurus 856 (2")	8
Pocket Size Auto	Ruger LCP, S&W Bodyguard 380, Glock 42, Sig P365, Colt Mustang, Sig 238	1
Micro Compact Auto	Glock 43/43X, Ruger LC9/EC9, Glock 26, Springfield Hellcat, S&W Shield/Shield Plus 9/40	5
Sub Compact Auto	Glock 48, S&W Shield EZ9/380, Sig P365XL, Colt Commander 4" 1911, Springfield Hellcat RDP	7
Compact Auto	Sig P320 Compact/M18, Glock 19, S&W M&P Compact 9/40, Sig P229, CZ P10-C	6
Full Size Auto	Sig P320/M17, Glock 17/22, Glock 21, S&W M&P 9/40, Colt Govt 5" 1911, Sig P226, Beretta 92	3

ADDITIONAL, SIMILAR SIZES ALSO AVAILABLE



SERPA® CQC® CONCEALMENT HOLSTER

- SERPA® Auto Lock™ release
- Passive retention detent adjustment screw
- Speed-cut design for rapid draw, target acquisition and re-holster
- Includes Belt Loop Platform and Paddle Platform
- Fits Shoulder, S.T.R.I.K.E.®, Quick Disconnect and Tactical Holster Platforms

SEE NEXT PAGE FOR FITS CHART AND MSRP



SERPA® CQC® CONCEALMENT HOLSTER / CARBON FIBER

- SERPA® Auto Lock™ release
- Passive retention detent adjustment screw
- Speed-cut design for rapid draw, target acquisition and re-holster
- Includes Belt Loop Platform and Paddle Platform
- Fits Shoulder, S.T.R.I.K.E.®, Quick Disconnect and Tactical Holster Platforms

SEE NEXT PAGE FOR FITS CHART AND MSRP





SERPA® CQC® CONCEALMENT HOLSTER

PART NUMBER	GUN FIT	SIZE	COLOR	MSRP	MTO	NSN
410500BK-L	Glock 17/22/31/47, Not Gen 5 .40	00	Black	\$50.95		
410500BK-R	Glock 17/22/31/47, Not Gen 5 .40	00	Black	\$50.95		
410500CT-L	Glock 17/22/31/47, Not Gen 5 .40	00	Coyote Tan	\$50.95	MTO	
410500CT-R	Glock 17/22/31/47, Not Gen 5 .40	00	Coyote Tan	\$50.95		
410501BK-L	Glock 26/27/33, Not Gen 5 .40	01	Black	\$50.95		
410501BK-R	Glock 26/27/33, Not Gen 5 .40	01	Black	\$50.95		1095-01-571-6864
410502BK-L	Glock 19/23/32/36/45, Not Gen 5 .40	02	Black	\$50.95		
410502BK-R	Glock 19/23/32/36/45, Not Gen 5 .40	02	Black	\$50.95		1095-01-571-6864
410502CT-R	Glock 19/23/32/36/45, Not Gen 5 .40	02	Coyote Tan	\$50.95		
410503BK-L	Colt 1911 Gov't & Clones w/ or w/o rail, Not All Clones	03	Black	\$50.95		
410503BK-R	Colt 1911 Gov't & Clones w/ or w/o rail, Not All Clones	03	Black	\$50.95		
410503CT-L	Colt 1911 Gov't & Clones w/ or w/o rail, Not All Clones	03	Coyote Tan	\$50.95		
410503CT-R	Colt 1911 Gov't & Clones w/ or w/o rail, Not All Clones	03	Coyote Tan	\$50.95		
410504BK-L	Beretta 92/96/M9 (Not Elite, Brig., or M9A1)	04	Black	\$50.95		
410504BK-R	Beretta 92/96/M9 (Not Elite, Brig., or M9A1)	04	Black	\$50.95		
410504CT-L	Beretta 92/96/M9 (Not Elite, Brig., or M9A1)	04	Coyote Tan	\$50.95		
410504CT-R	Beretta 92/96/M9 (Not Elite, Brig., or M9A1)	04	Coyote Tan	\$50.95		
410504FG-L	Beretta 92/96/M9 (Not Elite, Brig., or M9A1)	04	Foliage Green	\$50.95		
410504FG-R	Beretta 92/96/M9 (Not Elite, Brig., or M9A1)	04	Foliage Green	\$50.95		
410505BK-R	Sig 228/229/250DC w/ or w/o rail	05	Black	\$50.95		1095-01-573-2161
410506BK-L	Sig 220/225/226/228/229, MK25 w/ or w/o rail (not ES)	06	Black	\$50.95		1095-01-560-2098
410506BK-R	Sig 220/225/226/228/229, MK25 w/ or w/o rail (not ES)	06	Black	\$50.95		1095-01-560-2097
410506CT-L	Sig 220/225/226/228/229, MK25 w/ or w/o rail (not ES)	06	Coyote Tan	\$50.95		1095-01-560-6028
410506CT-R	Sig 220/225/226/228/229, MK25 w/ or w/o rail (not ES)	06	Coyote Tan	\$50.95		1095-01-560-6029
410507BK-L	Springfield XD/Mod.2/XDM 3.8"-4"	07	Black	\$50.95		
410507BK-R	Springfield XD/Mod.2/XDM 3.8"-4"	07	Black	\$50.95		
410507CT-R	Springfield XD/Mod.2/XDM 3.8"-4"	07	Coyote Tan	\$50.95		
410508BK-L	Sig Pro 2022	08	Black	\$50.95		
410508BK-R	Sig Pro 2022	08	Black	\$50.95		
410509BK-L	H&K P2000 / USP Compact	09	Black	\$50.95		
410509BK-R	H&K USP Compact	09	Black	\$50.95		
410510BK-L	S&W 5900/4000 9/.40 including TSW	10	Black	\$50.95		
410510BK-R	S&W 5900/4000 9/.40 including TSW	10	Black	\$50.95		
410511BK-R	Ruger P85/89	11	Black	\$50.95		
410512BK-R	Ruger P95	12	Black	\$50.95		
410513BK-L	Glock 20/21/37 & S&W M&P .45 & 9/.40 Pro	13	Black	\$50.95		
410513BK-R	Glock 20/21/37 & S&W M&P .45 & 9/.40 Pro	13	Black	\$50.95		
410513CT-R	Glock 20/21/37 & S&W M&P .45 & 9/.40 Pro	13	Coyote Tan	\$50.95		
410514BK-L	H&K USP Full Size 9/.40	14	Black	\$50.95		8465-01-554-1462
410514BK-R	H&K USP Full Size 9/.40	14	Black	\$50.95		8465-01-555-1503
410514CT-L	H&K USP Full Size 9/.40	14	Coyote Tan	\$50.95		
410514CT-R	H&K USP Full Size 9/.40	14	Coyote Tan	\$50.95		
410514OD-R	H&K USP Full Size 9/.40	14	Olive Drab	\$50.95		
410516BK-R	H&K P2000 (Not P2000SK)	16	Black	\$50.95		
410517BK-L	H&K P30 (not P30SK)	17	Black	\$50.95		
410517BK-R	H&K P30 (not P30SK)	17	Black	\$50.95		
410519BK-R	Taurus 24/7 OSS 9/.40 (not G2)	19	Black	\$50.95		
410520BK-L	S&W J-frame 2" (not .357)	20	Black	\$50.95		
410520BK-R	S&W J-frame 2" (not .357)	20	Black	\$50.95		
410524BK-L	Walther P99/ S&W SW99	24	Black	\$50.95		
410524BK-R	Walther P99/ S&W SW99	24	Black	\$50.95		
410525BK-L	S&W M&P 9/.357 Sig/.40 & SD9/40 (not CORE)	25	Black	\$50.95		
410525BK-R	S&W M&P 9/.357 Sig/.40 & SD9/40 (not CORE)	25	Black	\$50.95		
410525CT-R	S&W M&P 9/.357 Sig/.40 & SD9/40 (not CORE)	25	Coyote Tan	\$50.95		
410528BK-R	Beretta PX4 Storm	28	Black	\$50.95		
410529BK-R	Taurus 24/7 9/.40	29	Black	\$50.95		
410530BK-L	Glock 29/30/39 (not 30S)	30	Black	\$50.95		
410530BK-R	Glock 29/30/39 (not 30S)	30	Black	\$50.95		
410531BK-L	Springfield XD 3"Sub-comp/Mod.2 3"/3.3"	31	Black	\$50.95		
410531BK-R	Springfield XD 3"Sub-comp/Mod.2 3"/3.3"	31	Black	\$50.95		
410532BK-R	Taurus 85 2" 5-Shot .38 (Some models)	32	Black	\$50.95		
410540BK-R	Taurus Judge (2.5" Cylinder)	40	Black	\$50.95		
410541BK-R	Ruger SR9/9E (not SR22/SR40)	41	Black	\$50.95		
410542BK-R	1911 Commander & clones w/ or w/o rail	42	Black	\$50.95		
410543BK-L	Caracal F (w/o quick acquisition sight)	43	Black	\$50.95		
410543BK-R	Caracal F (w/o quick acquisition sight)	43	Black	\$50.95		
410544BK-R	Taurus Judge 3" Cylinder	44	Black	\$50.95		
410558BK-R	Ruger 57	58	Black	\$50.95		
410559BK-R	S&W M&P Shield +	59	Black	\$50.95		
410559BK-L	S&W M&P Shield +	59	Black	\$50.95		
410561BK-L	Sig P320/P250 (not sub compact or P320 .45)	61	Black	\$50.95		
410561BK-R	Sig P320/P250 (not sub compact or P320 .45)	61	Black	\$50.95		

SERPA® CQC® CONCEALMENT HOLSTER CONTINUED

PART NUMBER	GUN FIT	SIZE	COLOR	MSRP	MTO	NSN
410562BK-L	CZ 75/75B/75 SP01/85B	62	Black	\$50.95		
410562BK-R	CZ 75/75B/75 SP01/85B	62	Black	\$50.95		
410563BK-L	S&W M&P Shield 9/.40	63	Black	\$50.95		
410563BK-R	S&W M&P Shield 9/.40	63	Black	\$50.95		
410564BK-L	FNH FNS 9/.40	64	Black	\$50.95		
410564BK-R	FNH FNS 9/.40	64	Black	\$50.95		
410565BK-L	Springfield XDS 3.3"	65	Black	\$50.95		
410565BK-R	Springfield XDS 3.3"	65	Black	\$50.95		
410567BK-L	Glock 42	67	Black	\$50.95		
410567BK-R	Glock 42	67	Black	\$50.95		
410568BK-L	Glock 43	68	Black	\$50.95		
410568BK-R	Glock 43/43x/48	68	Black	\$50.95		
410570BK-R	Sig P365/P365XL	70	Black	\$50.95		
410071BK-R	Ruger Security 9	71	Black	\$50.95		
410576BK-R	Glock 48 w/ or w/o Rail	76	Black	\$50.95		
410577BK-R	Springfield Hellcat	77	Black	\$50.95		
410579BK-L	H&K VP9/.40/VP9SK	79	Black	\$50.95		
410579BK-R	H&K VP9/.40/VP9SK	79	Black	\$50.95		
410583BK-L	Taurus PT111/140 G2	83	Black	\$50.95		
410583BK-R	Taurus PT111/140 G2	83	Black	\$50.95		
410583BK-L	Taurus G2/G3C	83	Black	\$50.95		
410583BK-R	Taurus G2/G3C	83	Black	\$50.95		
410587BK-R	Taurus GX4	87	Black	\$50.95		

SERPA® CQC® CONCEALMENT HOLSTER / CARBON FIBER FINISH

PART NUMBER	GUN FIT	SIZE	COLOR	MSRP	MTO	NSN
410000BK-L	Glock 17/22/31/47, Not Gen 5 .40	00	Black	\$61.95		1095-01-578-7344
410000BK-R	Glock 17/22/31/47, Not Gen 5 .40	00	Black	\$61.95		
410001BK-L	Glock 26/27/33, Not Gen 5 .40	01	Black	\$61.95		
410001BK-R	Glock 26/27/33, Not Gen 5 .40	01	Black	\$61.95		
410002BK-L	Glock 19/23/32/36/45, Not Gen 5 .40	02	Black	\$61.95		
410002BK-R	Glock 19/23/32/36/45, Not Gen 5 .40	02	Black	\$61.95		
410003BK-L	Colt 1911 Gov't & Clones w/ or w/o rail, Not All Clones	03	Black	\$61.95		
410003BK-R	Colt 1911 Gov't & Clones w/ or w/o rail, Not All Clones	03	Black	\$61.95		
410004BK-L	Beretta 92/96/M9 (Not Elite, Brig., or M9A1)	04	Black	\$61.95		
410004BK-R	Beretta 92/96/M9 (Not Elite, Brig., or M9A1)	04	Black	\$61.95		
410005BK-R	Sig 228/229/250DC w/ or w/o rail	05	Black	\$61.95		
410006BK-L	Sig 220/225/226/228/229, MK25 w/ or w/o rail (not ES)	06	Black	\$61.95		1095-01-614-1164
410006BK-R	Sig 220/225/226/228/229, MK25 w/ or w/o rail (not ES)	06	Black	\$61.95		1095-01-614-1639
410007BK-L	Springfield XD/Mod.2/XDM 3.8"-4"	07	Black	\$61.95		
410007BK-R	Springfield XD/Mod.2/XDM 3.8"-4"	07	Black	\$61.95		
410008BK-L	Sig Pro 2022	08	Black	\$61.95		
410008BK-R	Sig Pro 2022	08	Black	\$61.95		
410009BK-L	H&K P2000 / USP Compact	09	Black	\$61.95	MTO	
410009BK-R	H&K USP Compact	09	Black	\$61.95		
410010BK-L	S&W 5900/4000 9/.40 including TSW	10	Black	\$61.95		
410010BK-R	S&W 5900/4000 9/.40 including TSW	10	Black	\$61.95		
410011BK-R	Ruger P85/89	11	Black	\$61.95		
410013BK-L	Glock 20/21/37 & S&W M&P .45 & 9/.40 Pro	13	Black	\$61.95		
410013BK-R	Glock 20/21/37 & S&W M&P .45 & 9/.40 Pro	13	Black	\$61.95		
410014BK-L	H&K USP Full Size 9/.40	14	Black	\$61.95		
410014BK-R	H&K USP Full Size 9/.40	14	Black	\$61.95		
410016BK-R	H&K P2000 (Not P2000SK)	16	Black	\$61.95		
410017BK-L	H&K P30 (not P30SK)	17	Black	\$61.95		
410017BK-R	H&K P30 (not P30SK)	17	Black	\$61.95		
410019BK-R	Taurus 24/7 OSS 9/.40 (not G2)	19	Black	\$61.95		
410024BK-L	Walther P99/ S&W SW99	24	Black	\$61.95		
410024BK-R	Walther P99/ S&W SW99	24	Black	\$61.95		
410025BK-L	S&W M&P 9/.357 Sig/.40 & SD9/40 (not CORE)	25	Black	\$61.95		
410025BK-R	S&W M&P 9/.357 Sig/.40 & SD9/40 (not CORE)	25	Black	\$61.95		
410028BK-R	Beretta PX4 Storm	28	Black	\$61.95		
410029BK-R	Taurus 24/7 9/.40 (not G2)	29	Black	\$61.95		
410030BK-R	Glock 29/30/39 (not 30S)	30	Black	\$61.95		
410031BK-L	Springfield XD 3"Sub-comp/Mod.2 3"/3.3"	31	Black	\$61.95		
410031BK-R	Springfield XD 3"Sub-comp/Mod.2 3"/3.3"	31	Black	\$61.95		
410041BK-R	Ruger SR9/9E (not SR22/SR40)	41	Black	\$61.95		
410042BK-R	1911 Commander & clones w/ or w/o rail , not polymer frame	42	Black	\$61.95		
410043BK-L	Caracal F (w/o quick acquisition sight)	43	Black	\$61.95		
410043BK-R	Caracal F (w/o quick acquisition sight)	43	Black	\$61.95		

BORN FROM EXPERIENCE. MADE FOR THE MISSION.

NEW PRODUCTS

HOLSTERS

DUTY & PROTECTIVE

APPAREL

BAGS & POUCHES

ACCESSORIES





A.R.C. IWB HOLSTERS

- Soft, durable injection-molded material designed for comfort
- Fully ambidextrous design allows for left- and right-handed use
- Designed for both civilian and law enforcement concealed carry
- Packaged with two cant and ride height adjustment belt clips for 1.5" and 1.75" belts
- Allows for use of rear-mounted red dot sights
- Made in the USA

PART NUMBER	GUN FIT	SIZE	COLOR	MSRP
417500UG	Glock 17/22/31/47, not Gen 5 .40	00	Urban Gray	\$24.95
417502UG	Glock 19/23/32/45, not Gen 5 .40	02	Urban Gray	\$24.95
417507UG	Springfield XD/XDM/Mod.2	07	Urban Gray	\$24.95
417520UG	S&W J-Frame	20	Urban Gray	\$24.95
417525UG	S&W M&P 9/.40/.45 & M&P Shield .45	25	Urban Gray	\$24.95
417549UG	Ruger EC9/LC380/LC9	49	Urban Gray	\$24.95
417563UG	S&W M&P Shield 9/.40	63	Urban Gray	\$24.95
417565UG	Springfield XDS	65	Urban Gray	\$24.95
417567UG	Glock 42	67	Urban Gray	\$24.95
417568UG	Glock 43/Springfield Hellcat/Kahr PM9/40	68	Urban Gray	\$24.95
417570UG	Sig P365	70	Urban Gray	\$24.95
417571UG	Ruger Security 9	71	Urban Gray	\$24.95
417576UG	Glock 48/S&W EZ .380/9mm	57	Urban Gray	\$24.95
417578UG	Sig P365XL	78	Urban Gray	\$24.95
417585UG	Ruger MAX 9	85	Urban Gray	\$24.95
417587UG	Taurus GX4	87	Urban Gray	\$24.95





STANDARD CQC HOLSTER

- Pressure adjustable detent retention system grabs onto the pistol's trigger guard and holds tight
- Available in matte finish only
- Includes CQC® belt loop and paddle platform
- Made in the USA

PART NUMBER	GUN FIT	SIZE	COLOR	MSRP
415600BK-L	Glock 17/22/31/47, Not Gen 5 .40	00	Black	\$24.95
415600BK-R	Glock 17/22/31/47, Not Gen 5 .40	00	Black	\$24.95
415601BK-R	Glock 26/27/33, Not Gen 5 .40	01	Black	\$24.95
415602BK-L	Glock 19/23/32/36/45, Not Gen 5 .40	02	Black	\$24.95
415602BK-R	Glock 19/23/32/36/45, Not Gen 5 .40	02	Black	\$24.95
415604BK-R	Beretta 92/96/M9/M9A1 (Not Elite, Brig.)	04	Black	\$24.95
415605BK-R	Sig 228/229/250DC w/ or w/o rail	05	Black	\$24.95
415606BK-R	Sig 220/225/226 w/ or w/o rail (not ES)	06	Black	\$24.95
415607BK-R	Springfield XD/Mod.2/XDM 3.8"-4"	07	Black	\$24.95
415609BK-R	H&K USP Compact	09	Black	\$24.95
415613BK-R	Glock 20/21/37 & S&W M&P .45 & 9/40 Pro	13	Black	\$24.95
415625BK-R	S&W M&P 9/.357 Sig/.40 & SD9/40 (not CORE)	25	Black	\$24.95
415641BK-R	Ruger SR9/9E (not SR22/SR40)	41	Black	\$24.95
415642BK-R	1911 Commander & clones w/ or w/o rail, not all clones	42	Black	\$24.95
415645BK-R	S&W M&P .45 & 9/40 Pro	45	Black	\$24.95
415649BK-R	Ruger LC9/LC380 w/o laser	49	Black	\$24.95
415663BK-L	S&W M&P Shield 9/.40	63	Black	\$24.95
415663BK-R	S&W M&P Shield 9/.40	63	Black	\$24.95



SERPA® SPORTSTER® HOLSTER

- SERPA® Auto Lock™ release
- Passive retention detent adjustment screw
- Gunmetal grey holster body with black locking mechanism
- Speed-cut design for rapid draw, target acquisition and re-holster
- Includes paddle platform only
- Fits Shoulder, S.T.R.I.K.E.®, Quick Disconnect and Tactical Holster Platforms
- Made in the USA

PART NUMBER	GUN FIT	SIZE	COLOR	MSRP
413500BK-L	Glock 17/22/31/47, Not Gen 5 .40	00	Gunmetal Gray	\$34.95
413500BK-R	Glock 17/22/31/47, Not Gen 5 .40	00	Gunmetal Gray	\$34.95
413501BK-L	Glock 26/27/33, Not Gen 5 .40	01	Gunmetal Gray	\$34.95
413501BK-R	Glock 26/27/33, Not Gen 5 .40	01	Gunmetal Gray	\$34.95
413502BK-L	Glock 19/23/32/36/45, Not Gen 5 .40	02	Gunmetal Gray	\$34.95
413502BK-R	Glock 19/23/32/36/45, Not Gen 5 .40	02	Gunmetal Gray	\$34.95
413503BK-L	Colt 1911 Gov't & Clones w/ or w/o rail, Not All Clones	03	Gunmetal Gray	\$34.95
413503BK-R	Colt 1911 Gov't & Clones w/ or w/o rail, Not All Clones	03	Gunmetal Gray	\$34.95
413504BK-L	Beretta 92/96/M9 (Not Elite, Brig., or M9A1)	04	Gunmetal Gray	\$34.95
413504BK-R	Beretta 92/96/M9 (Not Elite, Brig., or M9A1)	04	Gunmetal Gray	\$34.95
413505BK-R	Sig 228/229/250DC w/ or w/o rail	05	Gunmetal Gray	\$34.95
413506BK-L	Sig 220/225/226/228/229, MK25 w/ or w/o rail (not ES)	06	Gunmetal Gray	\$34.95
413506BK-R	Sig 220/225/226/228/229, MK25 w/ or w/o rail (not ES)	06	Gunmetal Gray	\$34.95
413507BK-R	Springfield XD/Mod.2/XDM 3.8"-4"	07	Gunmetal Gray	\$34.95
413509BK-R	H&K USP Compact	09	Gunmetal Gray	\$34.95
413510BK-L	S&W 5900/4000 9/.40 including TSW	10	Gunmetal Gray	\$34.95
413510BK-R	S&W 5900/4000 9/.40 including TSW	10	Gunmetal Gray	\$34.95
413513BK-L	Glock 20/21/37 & S&W M&P .45 & 9/40 Pro	13	Gunmetal Gray	\$34.95
413513BK-R	Glock 20/21/37 & S&W M&P .45 & 9/40 Pro	13	Gunmetal Gray	\$34.95
413514BK-L	H&K USP Full Size 9/.40	14	Gunmetal Gray	\$34.95
413514BK-R	H&K USP Full Size 9/.40	14	Gunmetal Gray	\$34.95
413525BK-L	S&W M&P 9/.357 Sig/.40 & SD9/40 (not CORE)	25	Gunmetal Gray	\$34.95
413525BK-R	S&W M&P 9/.357 Sig/.40 & SD9/40 (not CORE)	25	Gunmetal Gray	\$34.95



OMNIVORE™ NON-LIGHT BEARING

- OMNIVORE™ Holsters fit more than 200 styles of semi-automatic handguns with an accessory rail
- Ergonomic thumb-activated retention mechanism delivers instant firearm access
- Uses two features to hold handgun securely in place
- Holster locks onto Rail Attachment Device (Non-LB) or frame of the light and doesn't wear on firearm's frame and finish
- Not intended for Duty use
- Not for use on firearms with thumb activated safety or decocker
- Made in the USA

SEE NEXT PAGE FOR ADDITIONAL FITS LIST

PART NUMBER	GUN FIT	COLOR	MSRP
419000BBL	Non-Light Bearing pistols w/Picatinny Rail	Black	\$59.95
419000BBR	Non-Light Bearing pistols w/Picatinny Rail	Black	\$59.95
419000BCL	Non-Light Bearing pistols w/Picatinny Rail	Black/Tan	\$59.95
419000BCR	Non-Light Bearing pistols w/Picatinny Rail	Black/Tan	\$59.95
419000BUL	Non-Light Bearing pistols w/Picatinny Rail	Black/Gray	\$59.95
419000BUR	Non-Light Bearing pistols w/Picatinny Rail	Black/Gray	\$59.95



OMNIVORE™ SUREFIRE X300U-A/B

- OMNIVORE™ Holsters fit more than 200 styles of semi-automatic handguns with an accessory rail
- Ergonomic thumb-activated retention mechanism delivers instant firearm access
- Uses two features to hold handgun securely in place
- Holster locks onto Rail Attachment Device (Non-LB) or frame of the light and doesn't wear on firearm's frame and finish
- Not intended for Duty use
- Not for use on firearms with thumb activated safety or decocker
- Made in the USA

SEE NEXT PAGE FOR ADDITIONAL FITS LIST

PART NUMBER	GUN FIT	COLOR	MSRP
419001BBL	Surefire X-300/X-300U-A	Black	\$59.95
419001BBR	Surefire X-300/X-300U-A	Black	\$59.95
419001BCL	Surefire X-300/X-300U-A	Black/Tan	\$59.95
419001BCR	Surefire X-300/X-300U-A	Black/Tan	\$59.95
419001BUL	Surefire X-300/X-300U-A	Black/Gray	\$59.95
419001BUR	Surefire X-300/X-300U-A	Black/Gray	\$59.95



OMNIVORE™ STREAMLIGHT TLR-1/2

- OMNIVORE™ Holsters fit more than 200 styles of semi-automatic handguns with an accessory rail
- Ergonomic thumb-activated retention mechanism delivers instant firearm access
- Uses two features to hold handgun securely in place
- Holster locks onto Rail Attachment Device (Non-LB) or frame of the light and doesn't wear on firearm's frame and finish
- Not intended for Duty use
- Not for use on firearms with thumb activated safety or decocker
- Made in the USA

SEE NEXT PAGE FOR ADDITIONAL FITS LIST

PART NUMBER	GUN FIT	COLOR	MSRP
419002BBL	Streamlight TLR-1 & TLR-2	Black	\$59.95
419002BBR	Streamlight TLR-1 & TLR-2	Black	\$59.95
419002BCL	Streamlight TLR-1 & TLR-2	Black/Tan	\$59.95
419002BCR	Streamlight TLR-1 & TLR-2	Black/Tan	\$59.95
419002BUL	Streamlight TLR-1 & TLR-2	Black/Gray	\$59.95
419002BUR	Streamlight TLR-1 & TLR-2	Black/Gray	\$59.95



OMNIVORE™ HOLSTER FIT LIST CONTINUED

SIG SAUER

P226 EQUINOX, .40 S&W, 4.4"
 P226 EXTREME SAO, 9mm, 4.4"
 P226 MK25 RX NAVY, 9mm, 4.4"
 P226 MK25, NAVY, 9mm, 4.4"; BLACK, DESERT
 P226 MK25, NAVY, 9mm, 4.4"; TB, BLACK, DESERT
 P226 NITRON, .357 SIG, 4.4"
 P226 NITRON, .40 S&W, 4.4"
 P226 NITRON, 9mm, 4.4"
 P226 SCORPION, 9mm, 4.4"
 P226 SCORPION, 9mm, 4.4"; TB
 P226 TACOPS, .357 SIG, 4.4"
 P226 TACOPS, .40 S&W, 4.4"
 P226 TACOPS, 9mm, 4.4"
 P226 TACOPS, 9mm, 4.4"; TB
 P226 X-FIVE ALLROUND, .40 S&W, 5"
 P226 X-FIVE ALLROUND, 9mm, 5"
 P226 X-FIVE CLASSIC, .40 S&W, 5"
 P226 X-FIVE CLASSIC, 9mm, 5"
 P226 X-FIVE ENTRY, .40 S&W, 5"
 P226 X-FIVE ENTRY, 9mm, 5"
 P226 X-FIVE ENTRY, 9mm, 5"
 P226 X-FIVE MATCH, .40 S&W, 5"
 P226 X-FIVE MATCH, 9mm, 5"
 P226 X-FIVE SUPERMATCH, .40 S&W, 5"
 P226 X-FIVE SUPERMATCH, 9mm, 5"
 P226 X-FIVE TACTICAL, 9mm, 5"
 P226 X-SIX SUPERMATCH, .40 S&W, 6"
 P226 X-SIX SUPERMATCH, 9mm, 6"
 P229 COMBAT, 9mm, 3.9"
 P229 DAK, .357 SIG, 3.9"
 P229 DAK, .40 S&W, 3.9"
 P229 DAK, 9mm, 3.9"
 P229 E2, .40 S&W, 3.9"
 P229 E2, 9mm, 3.9"
 P229 ELITE STAINLESS, .40 S&W, 3.9"
 P229 ELITE STAINLESS, 9mm, 3.9"
 P229 ENHANCED ELITE, .357 SIG, 3.9"
 P229 ENHANCED ELITE, .40 S&W, 3.9"
 P229 ENHANCED ELITE, 9mm, 3.9"
 P229 EQUINOX, .40 S&W, 3.9"
 P229 EXTREME, 9mm, 3.9"
 P229 SAS GEN 2, .357 SIG, 3.9"
 P229 SAS GEN 2, .40 S&W, 3.9"
 P229 SAS GEN 2, 9mm, 3.9"
 P229 SCORPION, .40 S&W, 3.9"
 P229 SCORPION, 9mm, 3.9"
 P229 SCORPION, 9mm, 3.9"; TB
 P229, .357 SIG, 3.9"
 P229, .40 S&W, 3.9"
 P229, 9mm, 3.9"
 P250 22 COMPACT, .22 LR, 3.9"
 P250 COMPACT, .357 SIG, 3.9"
 P250 COMPACT, .40 S&W, 3.9"
 P250 COMPACT, .45 ACP, 3.9"
 P250 COMPACT, 9mm, 3.9"
 P250 COMPACT, 9mm, 3.9"; TB

HECKLER & KOCH

P2000, .40 S&W, 3.66"
 P2000, 9mm, 3.66"
 VP40 TACTICAL, .40 S&W
 VP40, .40 S&W, 4.09"; BLACK, FDE
 VP9 TACTICAL, 9mm, 4.7"; TB
 VP9, 9mm, 4.09"

RUGER

AMERICAN PRO, .45 ACP, 4.5"
 AMERICAN PRO, 9mm, 4.2"

SMITH & WESSON

M&P 40 PERFORMANCE CENTER PORTED, .40 4.25"
 M&P 40 PERFORMANCE CENTER PORTED, .40 5"
 M&P 40 PRO SERIES C.O.R.E., .40 S&W, 4.25"
 M&P 40 PRO SERIES, .40 S&W, 4.25"
 M&P 40 PRO SERIES, .40 S&W, 5"
 M&P 40, .40 S&W, 4.25"
 M&P 40L PRO SERIES C.O.R.E., .40 S&W, 5"
 M&P 45 .45 ACP, 4"
 M&P 45 .45 ACP, 4.5"
 M&P 45, .45 ACP, 4.5"
 M&P 45C COMPACT, .45 ACP, 4"
 M&P 9 C.O.R.E. TREADED BARREL, 9mm, 4.25"; TB
 M&P 9 PERFORMANCE CENTER PORTED, 9mm, 4"
 M&P 9 PERFORMANCE CENTER PORTED, 9mm, 5"
 M&P 9 PRO SERIES C.O.R.E., 9mm, 4.25"
 M&P 9 PRO SERIES, 9mm, 4.25"
 M&P 9 PRO SERIES, 9mm, 5"
 M&P 9 PRO SERIES, 9mm, 5"
 M&P 9 VTAC VIKING TACTICS FDE, 9mm, 4.25"
 M&P 9, 9mm, 4.25"
 M&P 9L C.O.R.E., 9mm, 5"
 SD40 VE, .40 S&W, 4"; W/SLOTTED RAIL
 SD9 VE, 9mm, 4"

SIG SAUER

P220 CARRY ELITE STAINLESS, .45 ACP, 3.9"
 P220 CARRY, .45 ACP, 3.9"
 P220 COMBAT, .45 ACP, 5"; TB
 P220 ELITE STAINLESS, .45 ACP, 4.4"
 P220, .45 ACP, 4.4"
 P226 EXTREME, .40 S&W, 4.4"
 P226 EXTREME, 9mm, 4.4"
 P226 COMBAT, 9mm, 4.4"
 P226 COMBAT, 9mm, 4.4"; TB
 P226 DAK, .357 SIG, 4.4"
 P226 DAK, .40 S&W, 4.4"
 P226 DAK, 9mm, 4.4"
 P226 ELITE STAINLESS, .40 S&W, 4.4"
 P226 ELITE STAINLESS, 9mm, 4.4"
 P226 ENGRAVED STAINLESS, 9mm, 4.4"
 P226 ENHANCED ELITE, .357 SIG, 4.4"
 P226 ENHANCED ELITE, .40 S&W, 4.4"
 P226 ENHANCED ELITE, 9mm, 4.4"

SIG SAUER

P250 DC, 9mm, 3.9"
 P250 FULL SIZE, .357 SIG, 4.7"
 P250 FULL SIZE, .40 S&W, 4.7"
 P250 FULL SIZE, .45 ACP, 4.7"
 P250 FULL SIZE, 9mm, 4.7"
 P320 CARRY, .357 SIG, 3.9"
 P320 CARRY, .357 SIG, 3.9"; TB
 P320 CARRY, .40 S&W, 3.9"
 P320 CARRY, .40 S&W, 3.9"; TB
 P320 CARRY, .45 ACP, 3.9"
 P320 CARRY, .45 ACP, 3.9"; TB
 P320 CARRY, 9mm, 3.9"
 P320 CARRY, 9mm, 3.9"; TB
 P320 COMPACT, .357 SIG, 3.9"
 P320 COMPACT, .357 SIG, 3.9"; TB
 P320 COMPACT, .40 S&W, 3.9"
 P320 COMPACT, .40 S&W, 3.9"; TB
 P320 COMPACT, .45 ACP, 3.9"
 P320 COMPACT, .45 ACP, 3.9"; TB
 P320 COMPACT, 9mm, 3.9"
 P320 COMPACT, 9mm, 3.9"; TB
 P320 FULL SIZE, .357 SIG, 4.7"
 P320 FULL SIZE, .40 S&W, 4.7"
 P320 FULL SIZE, .40 S&W, 4.7"; TB
 P320 FULL SIZE, .45 ACP, 4.7"
 P320 FULL SIZE, .45 ACP, 4.7"; TB
 P320 FULL SIZE, 9mm, 4.7"
 P320 FULL SIZE, 9mm, 4.7"; TB
 SP2022 FDE BG, .40 S&W, 4.4"
 SP2022 FDE BG, 9mm, 4.4"
 SP2022 NITRON, 9mm, 3.9"; TB
 SP2022, .357 SIG, 4.4"
 SP2022, .40 S&W, 3.9"
 SP2022, 9mm, 3.9"
 SPRINGFIELD
 XD-40 FULL SIZE, .40 S&W, 4"
 XD-40 FULL SIZE, .40 S&W, 5"
 XD-40 MOD 2 SERVICE MODEL, .40 S&W, 4"
 XD-40 SERVICE MODEL, .40 S&W, 4"
 XD-40 TACTICAL, .40 S&W, 5"
 XD-45 .45 ACP, 5"
 XD-45 SERVICE MODEL, .45 ACP, 4"
 XD-9 9mm, 5"
 XD-9 MOD 2 SERVICE MODEL, 9mm, 4"
 XD-9 MOD 2 SERVICE MODEL, 9mm, 4"; TB
 XD-9 MOD 2 TACTICAL, 9mm, 5"
 XD-9 SERVICE MODEL, 9mm, 4"
 XDM-40 COMPACT, .40 S&W, 3.8"
 XDM-40 COMPETITION SERIES, .40 S&W, 5.25"
 XDM-40, .40 S&W, 3.8"
 XDM-40, .40 S&W, 4.5"
 XDM-45 COMPETITION SERIES, .45 ACP, 5.25"
 XDM-45, .45 ACP, 4.5"

BROWNING

PRO-40, .40 S&W, 4"
 PRO-9, 9mm, 4"

CARACAL

ENHANCED F, 9mm, 4.1"
 9mm, 4.1"

CENTURY ARMS

CANiK TP9 SA, 9mm, 4.47"
 CANiK TP9 SF, 9mm, 4.46"
 CANiK TP9, 9mm, 4.5"

CZ

P-07 URBAN GREY SUPPRESSOR READY, 9mm, 4.36"; TB
 P-07, .40 S&W, 3.75"
 P-07, 9mm, 3.75"
 P-09 SUPPRESSOR READY, 9mm, 5.15"; TB
 P-09 URBAN GREY SUPPRESSOR READY, 9mm, 5.15"; TB
 P-09, 9mm, 5.54"

FNH

FNS-40 LONGSLIDE, .40 S&W, 5"
 FNS-40, .40 S&W, 4"
 FNS-9 LONGSLIDE, 9mm, 5"
 FNS-9, 9mm, 4"

GLOCK

G17 GEN4 MOS, 9mm, 4.48"
 G17 P, NONE, 4.48"; PRACTICE
 G17 T FX, NONE, 4.48"; TRAINING
 G17, 9mm, 4.48"; GEN3, GEN4
 G19 GEN4 MOS, 9mm, 4.01"
 G19, 9mm, 4.01"; GEN3, GEN4
 G20, 10mm, 4.6"; GEN3, GEN4
 G21 SF GEN3 PICATINNY RAIL, .45 ACP, 4.6"
 G21 SF, .45 ACP, 4.6"; GEN3, GEN4
 G22, .40 S&W, 4.01"; GEN3, GEN4
 G22 P, NONE, 4.49"; PRACTICE
 G23, .40 S&W, 4.01"; GEN3, GEN4
 G29, 10mm, 3.77"; GEN3, GEN4
 G30 SF, .45 ACP, 3.77"; GEN3, GEN4
 G30, .45 ACP, 3.77"; GEN3, GEN4
 G30S GEN3, .45 ACP, 3.77"
 G31, .357 SIG, 4.48"; GEN3, GEN4
 G34 GEN4 MOS, 9mm, 5.31"
 G34, 9mm, 5.35"; GEN3, GEN4
 G35 GEN4 MOS, .40 S&W, 5.31"
 G35, .40 S&W, 5.31"; GEN3, GEN4
 G37, .45 G.A.P., 4.48"; GEN3, GEN4
 G38 GEN3, .45 G.A.P., 4.01"
 G41 GEN4 MOS, .45 ACP, 5.31"
 G41 GEN4, .45 ACP, 5.31"

SPRINGFIELD

XDM-45, .45 ACP, 4.5"; TB
 XDM-9 COMPACT, 9mm, 3.8"
 XDM-9 COMPETITION SERIES, 9mm, 5.25"
 XDM-9 OSP FULL SIZE, 9mm, 4.5"
 XDM-9, 9mm, 3.8"
 XDM-9, 9mm, 4.5"
 XDM-9, 9mm, 4.5"; TB

WALTHER

P99 AS, .40 S&W, 3.5" *
 P99 AS, .40 S&W, 4.2" *
 P99 AS, 9mm, 3.5" *
 P99 AS, 9mm, 4" *
 P99 DAO, .40 S&W, 4.6" *
 P99 DAO, 9mm, 4" *
 P99 QA, .40 S&W, 4.6" *
 P99 QA, 9mm, 4" *
 P99, .40 S&W, 4.2" *
 P99, 9mm, 4" *
 P99C AS, .40 S&W, 3.5" **
 P99C AS, .40 S&W, 4.2" **
 P99C AS, 9mm, 3.5" **
 P99C AS, 9mm, 4" **
 P99C DAO, .40 S&W, 4.6" **
 P99C DAO, 9mm, 4" **
 P99C QA, .40 S&W, 4.6" **
 P99C QA, 9mm, 4" **
 PPQ 22 TACTICAL, .22 LR, 4.6"
 PPQ 22, .22 LR, 4"
 PPQ 22, .22 LR, 5"
 PPQ 45, .45 ACP, 4.25"
 PPQ CLASSIC, 9mm, 4"
 PPQ M2 NAVY, 9mm, 4.6"; TB
 PPQ M2, .40 S&W, 4.2"
 PPQ M2, .40 S&W, 5"
 PPQ M2, 9mm, 4"
 PPQ M2, 9mm, 5"
 PPX, .40 S&W, 4"
 PPX, 9mm, 4"
 Q5 MATCH, 9mm, 5"

*DOES NOT FIT OMNIVORE SUREFIRE X300/X300U-A LIGHT BEARING HOLSTERS.
 **DOES NOT FIT OMNIVORE SUREFIRE X300/X300U-A OR OMNIVORE STREAMLIGHT TLR-1/2 LIGHT BEARING HOLSTERS.
 THE APPROVED FIT LIST DOES NOT APPLY TO FIREARMS WITH A THUMB SAFETY AS OF NOV 16, 2016



TECGRIP® JUNK DRAWER

- Designed to carry in the appendix position with an extra magazine, the TecGrip material allows the holster to stay in place for all day wear and comfort
- Allows for left or right usage and the ability to tailor the carry to your desired location.
- The thermal bonded construction process binds the material together for strength and durability.
- Made in the USA

PART NUMBER	GUN FIT	SIZE	COLOR	MSRP
40JD04BK	Glock 42/Ruger LCPII/Micro 380S & Very Small frame .32/.380	04	Black	\$34.95
40JD05BK	Glock 43/43X/Shield 9/40/45/Hellcat/LC9 & Small Frame 9/40	05	Black	\$34.95
40JD06BK	Glock 19/26/27/M&P 9C/Taurus G2 & other 3.75"-4.5" Barrel Autos	06	Black	\$34.95



TECGRIP® MAG POUCHES

- Proprietary gripping material secures magazine in any pocket
- Ambidextrous design for left- and right-handed use
- Washable with soap and water; air dry
- Made in the USA

PART NUMBER	GUN FIT	COLOR	MSRP
40MP01BK	Full-Size Single/Double Stack Mags	Black	\$14.95
40MP02BK	Sub-Compact Single/Double Stack Mags	Black	\$14.95



TECGRIP® POCKET HOLSTERS

- Designed for both civilian and law enforcement concealed carry
- Proprietary gripping material secures holster in any pocket
- Ambidextrous design for left- and right-handed use
- Washable with soap and water; air dry
- Made in the USA

PART NUMBER	GUN FIT	SIZE	COLOR	MSRP
40TP01BK	Small Autos (.22/.25)	01	Black	\$18.95
40TP02BK	LCP/LC9/Bodyguard/P365/P238 & Most Small-Frame .380	02	Black	\$18.95
40TP03BK	Glock 42/43/Bersa Thunder & 2" 5-Shot Ruger, Kel-Tec, Kahr, and Taurus .380	03	Black	\$18.95
40TP04BK	Glock 42/43 w/Crimson Trace Laser & Most Sub-Compact 9/40 Autos	04	Black	\$18.95



TECGRIP® IWB HOLSTERS

- Designed for both civilian and law enforcement concealed carry
- Proprietary gripping material allows for clipless inside-the-waistband carry
- Fully ambidextrous design for left- and right-handed use
- Washable with soap and water; air dry
- Made in the USA

PART NUMBER	GUN FIT	SIZE	COLOR	MSRP
40IP00BK	2"-3" Barrel Small/Med Double Action Revolvers (Not 2" 5-Shot)	00	Black	\$24.95
40IP01BK	LC9 w/o Laser/Glock 42/Sig P238/P365/Ultra Carry 3"/XDS & 3"-4" Barrel Med.-Frame .32/.380 Autos	01	Black	\$24.95
40IP02BK	4" Barrel Med/Inter. Double Action Revolver	02	Black	\$24.95
40IP03BK	4.5"-5" Barrel Large Autos	03	Black	\$24.95
40IP04BK	Small Autos (.22/.25), Very Small Frame .32/.380	04	Black	\$24.95
40IP05BK	Glock 26/27/33/43/S&W Shield & Similar Sub-Compact 9/40	05	Black	\$24.95
40IP06BK	Glock 19 & other 3.75"-4.5" Barrel Large Autos	06	Black	\$24.95
40IP07BK	Springfield XD Mod 2/Taurus PT111 & other 3.25"-3.75" Barrel Med./Large Autos	07	Black	\$24.95
40IP08BK	Ruger LCR & 2" Barrel Small Frame 5-Shot Revolvers, Small frame .380 w/Crimson Trace	08	Black	\$24.95





INSIDE-THE-PANTS HOLSTER W/RETENTION STRAP

- Constructed of soft laminate suede-like outer material
- Smooth nylon lining for easy draw
- Belt clip slips over pants or belt to retain holster
- Fold-over hook & loop retention strap

PART NUMBER	GUN FIT	SIZE	COLOR	MSRP
73IR00BK-L	2" - 3" Barrel Small/Medium Double-Action Revolvers (Except 2" 5-Shot)	00	Black	\$19.95
73IR00BK-R	2" - 3" Barrel Small/Medium Double-Action Revolvers (Except 2" 5-Shot)	00	Black	\$19.95
73IR01BK-L	3" - 4" Barrel Medium-Frame .32/.380 Autos	01	Black	\$19.95
73IR01BK-R	3" - 4" Barrel Medium-Frame .32/.380 Autos	01	Black	\$19.95
73IR02BK-R	4" Barrel Medium and Intermediate Double-Action Revolvers	02	Black	\$19.95
73IR03BK-R	4.5" - 5" Barrel Large Autos	03	Black	\$19.95
73IR06BK-L	3.75" - 4.5" Barrel Large Autos	06	Black	\$19.95
73IR06BK-R	3.75" - 4.5" Barrel Large Autos	06	Black	\$19.95
73IR07BK-L	3.25" - 3.75" Barrel Medium/Large Autos	07	Black	\$19.95
73IR07BK-R	3.25" - 3.75" Barrel Medium/Large Autos	07	Black	\$19.95
73IR08BK-L	2" Barrel Small-Frame 5-Shot Revolvers, Small-Frame .380s with Crimson Trace	08	Black	\$19.95
73IR08BK-R	2" Barrel Small-Frame 5-Shot Revolvers, Small-Frame .380s with Crimson Trace	08	Black	\$19.95



NYLON 3-SLOT PANCAKE HOLSTER

- Gives the option of strong-side, kidney or crossdraw mounting options
- A reversible/adjustable retention strap with molded thumb break provides reliable weapon security
- Ambidextrous design
- Constructed of 1000 denier CORDURA® nylon outer material
- Lined with smooth, snag-resistant material
- Belt slots pull holster body close for maximum concealment
- Fits belts up to 1.75" wide

PART NUMBER	GUN FIT	SIZE	COLOR	MSRP
40PC00BK	2" - 3" Barrel Small/Medium Double-Action Revolvers (Except 2" 5-Shot)	00	Black	\$28.95
40PC01BK	3" - 4" Barrel Medium-Frame .32/.380 Autos	01	Black	\$28.95
40PC02BK	4" Barrel Medium and Intermediate Double-Action Revolvers	02	Black	\$28.95
40PC03BK	4.5" - 5" Barrel Large Autos	03	Black	\$28.95
40PC04BK	Glock 26/27/33 and other Sub-Compact 9/.40	04	Black	\$28.95
40PC05BK	3.75" - 4.5" Barrel Large Autos	05	Black	\$28.95
40PC06BK	3.25" - 3.75" Barrel Medium/Large Autos	06	Black	\$28.95



INSIDE-THE-PANTS HOLSTER

- Constructed of soft laminate suede-like outer material
- Smooth nylon lining for easy draw
- Belt clip slips over pants or belt to retain holster
- Fold-over hook & loop retention strap (73IR0 only)

PART NUMBER	GUN FIT	SIZE	COLOR	MSRP
73IP00BK	2" - 3" Barrel Small/Medium Double-Action Revolvers (Except 2" 5-Shot)	00	Black	\$13.95
73IP00BK-L	2" - 3" Barrel Small/Medium Double-Action Revolvers (Except 2" 5-Shot)	00	Black	\$13.95
73IP01BK	3" - 4" Barrel Medium-Frame .32/.380 Autos	01	Black	\$13.95
73IP01BK-L	3" - 4" Barrel Medium-Frame .32/.380 Autos	01	Black	\$13.95
73IP02BK	4" Barrel Medium and Intermediate Double-Action Revolvers	02	Black	\$13.95
73IP02BK-L	4" Barrel Medium and Intermediate Double-Action Revolvers	02	Black	\$13.95
73IP03BK	4.5" - 5" Barrel Large Autos	03	Black	\$13.95
73IP03BK-L	4.5" - 5" Barrel Large Autos	03	Black	\$13.95
73IP04BK	Small Autos (.22/.25) and Very Small-Frame .32 and .380s	04	Black	\$13.95
73IP04BK-L	Small Autos (.22/.25) and Very Small-Frame .32 and .380s	04	Black	\$13.95
73IP05BK	Glock 26/27/33 and other Sub-Compact 9/.40	05	Black	\$13.95
73IP05BK-L	Glock 26/27/33 and other Sub-Compact 9/.40	05	Black	\$13.95
73IP06BK	3.75" - 4.5" Barrel Large Autos	06	Black	\$13.95
73IP06BK-L	3.75" - 4.5" Barrel Large Autos	06	Black	\$13.95
73IP07BK	3.25" - 3.75" Barrel Medium/Large Autos	07	Black	\$13.95
73IP07BK-L	3.25" - 3.75" Barrel Medium/Large Autos	07	Black	\$13.95
73IP08BK	2" Barrel Small-Frame 5-Shot Revolvers, Small-Frame .380s with Crimson Trace	08	Black	\$13.95
73IP08BK-L	2" Barrel Small-Frame 5-Shot Revolvers, Small-Frame .380s with Crimson Trace	08	Black	\$13.95



NYLON BELT POUCH HOLSTER

- Constructed of 1000 denier CORDURA® nylon outer material
- Top zipper opening can remain open or closed without revealing weapon
- Discreet hook & loop flap inside pouch keeps handgun hidden
- Separate pocket on front of pouch holds keys, cuffs, camera, company patch or other items
- Dual belt loops fit belts up to 2" wide
- Mini model (40BP00) fits 2" 5-shot revolvers and sub-compact autos
- Large model (40BP01) fits 3" revolvers and medium- and large-frame semi-autos



PART NUMBER	GUN FIT	COLOR	MSRP
40BP00BK	Nylon Belt Pouch Holster - Mini	Black	\$45.95
40BP01BK	Nylon Belt Pouch Holster - Large	Black	\$48.95



NYLON AMBIDEXTROUS MULTI-USE HOLSTER

- Constructed of 1000 denier CORDURA® nylon outer material
- Removable spring-steel belt clip, for inside-the-waistband carry
- Reversible, non-stretch hook & loop retention strap with molded thumb break
- Fits belts up to 1.75" wide in a traditional vertical position
- Fits belts up to 1.5" wide in horizontal position (middle of the back)
- Holsters for semi-auto pistols include spare mag pouch with adjustable retention flap

PART NUMBER	GUN FIT	SIZE	COLOR	MSRP
40AM01BK	3" - 4" Barrel Medium-Frame .32/.380 Autos	01	Black	\$32.95
40AM02BK	4" Barrel Medium/Large Double-Action Revolvers	02	Black	\$32.95
40AM03BK	4.5" - 5" Barrel Large Autos	03	Black	\$33.45
40AM05BK	3.75" - 4.5" Barrel Large Autos	05	Black	\$33.45
40AM06BK	3.25" - 3.75" Barrel Medium/Large Autos	06	Black	\$33.45
40AM36BK	2" - 2.25" Small-Frame 5- and 6-Shot Revolvers with Hammer Spur	36	Black	\$32.95



NYLON LASER HOLSTER

- Carries popular-sized pistols with most under-barrel laser systems
- Constructed of 1000 denier CORDURA® nylon outer material
- Right hand only

PART NUMBER	GUN FIT	COLOR	SIZE	MSRP
40LH01BK	3" - 4" BBL Medium Autos with Most Under-Barrel Lasers	Black	01	\$29.95
40LH02BK	3.25" - 3.75" BBL Medium/Large-Frame Autos with Most Under-Barrel Lasers	Black	02	\$29.95
40LH03BK	Gov't 1911 with Most Under-Barrel Lasers	Black	03	\$29.95



NYLON CONCEALED WEAPON FANNY PACK HOLSTER

- Constructed of 1000 denier CORDURA® nylon outer material
- Retention belt loops attach to belt for extra security and retention
- Universal design fits most small- to medium-frame and medium- to large-frame semi-autos and revolvers

PART NUMBER	SIZE	COLOR	MSRP	NSN
60WF04BK	Small, 7.5"W x 5"H x 1.75"D	Black	\$71.45	
60WF05BK	Medium, 8.25"W x 5.5" H x 1.75" D	Black	\$71.45	8465-01-519-2350
60WF06BK	Large, 9" W x 6.5" H x 1.75" D	Black	\$71.45	8465-01-535-1410



NYLON AMBIDEXTROUS FLAT BELT HOLSTER

- Ambidextrous design
- Constructed of 1000 denier CORDURA® nylon outer material
- Fits belts up to 2" wide
- Adjustable, reversible thumb break
- Fits most small- to medium-frame and medium- to large-frame semi-autos and revolvers

PART NUMBER	GUN FIT	COLOR	MSRP
40FB02BK	Fits most small- to medium-frame and medium- to large-frame autos and revolvers	Black	\$21.95



NYLON HIP HOLSTER

- Constructed of 1000 denier CORDURA® nylon outer material
- Smooth nylon lining for easy draw
- Adjustable retention strap with non-glare snaps

SKU	SKU DESC - FIT	COLOR	SIZE	MSRP
73NH00BK-L	2" - 3" Barrel Small/Medium Double-Action Revolvers (Except 2" 5-Shot)	Black	00	\$20.45
73NH00BK-R	2" - 3" Barrel Small/Medium Double-Action Revolvers (Except 2" 5-Shot)	Black	00	\$20.45
73NH01BK-L	3" - 4" Barrel Medium .32/.380 Frame .32/.380 Autos	Black	01	\$20.45
73NH01BK-R	3" - 4" Barrel Medium .32/.380 Frame .32/.380 Autos	Black	01	\$20.45
73NH02BK-L	3" - 4" Barrel Medium/Large Double-Action Revolvers	Black	02	\$20.45
73NH02BK-R	3" - 4" Barrel Medium/Large Double-Action Revolvers	Black	02	\$20.45
73NH03BK-L	5" - 6.5" Barrel Medium/Large Double-Action Revolvers	Black	03	\$20.45
73NH03BK-R	5" - 6.5" Barrel Medium/Large Double-Action Revolvers	Black	03	\$20.45
73NH04BK-L	4.5" - 5" Barrel Large Autos, Open End	Black	04	\$20.45
73NH04BK-R	4.5" - 5" Barrel Large Autos, Open End	Black	04	\$20.45
73NH05BK-L	Small Autos (.22/.25) and Very Small-Frame .32 and .380s	Black	05	\$20.45
73NH05BK-R	Small Autos (.22/.25) and Very Small-Frame .32 and .380s	Black	05	\$20.45
73NH06BK-L	Glock 26/27/33 and other Sub-Compact 9/40	Black	06	\$20.45
73NH06BK-R	Glock 26/27/33 and other Sub-Compact 9/40	Black	06	\$20.45
73NH07BK-L	3.5" - 4.5" Barrel Large Autos, Open End	Black	07	\$20.45
73NH07BK-R	3.5" - 4.5" Barrel Large Autos, Open End	Black	07	\$20.45
73NH08BK-L	3.25" - 3.75" Barrel Medium/Large Autos	Black	08	\$20.45
73NH08BK-R	3.25" - 3.75" Barrel Medium/Large Autos	Black	08	\$20.45
73NH09BK-L	2" Small-Frame 5-Shot Revolvers with Hammer Spur	Black	09	\$20.45
73NH09BK-R	2" Small-Frame 5-Shot Revolvers with Hammer Spur	Black	09	\$20.45
73NH10BK-L	7" - 8.5" Barrel Medium/Large Double-Action Revolvers (Tie-Down Loop Included)	Black	10	\$20.45
73NH10BK-R	7" - 8.5" Barrel Medium/Large Double-Action Revolvers (Tie-Down Loop Included)	Black	10	\$20.45
73NH11BK-R	9.5" - 10.75" Barrel Single- and Double-Action Revolvers (Tie-Down Loop Included)	Black	11	\$20.45
73NH12BK-L	3" - 5" Barrel Single-Action Revolvers	Black	12	\$20.45
73NH12BK-R	3" - 5" Barrel Single-Action Revolvers	Black	12	\$20.45
73NH13BK-L	5.5" - 6.5" Barrel Single-Action Revolvers	Black	13	\$20.45
73NH13BK-R	5.5" - 6.5" Barrel Single-Action Revolvers	Black	13	\$20.45
73NH14BK-L	6.875" Barrel .22 Autos	Black	14	\$20.45
73NH14BK-R	6.875" Barrel .22 Autos	Black	14	\$20.45
73NH15BK-L	6.5" - 7.5" Barrel Single-Action Revolvers	Black	15	\$20.45
73NH15BK-R	6.5" - 7.5" Barrel Single-Action Revolvers	Black	15	\$20.45
73NH16BK-L	5.5" - 6" Barrel .22 Autos and Airguns	Black	16	\$20.45
73NH16BK-R	5.5" - 6" Barrel .22 Autos and Airguns	Black	16	\$20.45
73NH17BK-L	10.5" Barrel .22 Autos (Tie-Down Loop Included)	Black	17	\$20.45
73NH17BK-R	10.5" Barrel .22 Autos (Tie-Down Loop Included)	Black	17	\$20.45
73NH18BK-L	6" Raging Bull and 6" S&W N-Frame Full Lug	Black	18	\$20.45
73NH18BK-R	6" Raging Bull and 6" S&W N-Frame Full Lug	Black	18	\$20.45
73NH19BK-L	8" Raging Bull and 8.375" S&W N-Frame Full Lug	Black	19	\$20.45
73NH19BK-R	8" Raging Bull and 8.375" S&W N-Frame Full Lug	Black	19	\$20.45



NYLON UNIVERSAL SPEC OPS PISTOL HARNESS

- For cross-body in the vertical, horizontal or angled position
- Constructed of 1000 denier CORDURA® nylon outer material
- Padded and fully adjustable
- Fits most semi-auto pistols
- Right-hand model only

PART NUMBER	GUN FIT	COLOR	MSRP
40SH04BK	Nylon Universal Spec Ops Pistol Harness	Black	\$72.95



NYLON BEDSIDE HOLSTER

- Ambidextrous design
- Constructed of 1000 denier CORDURA® nylon outer material
- Mounting platform slips between mattress and box springs
- Securely stores pistol bedside for rapid access
- Works with revolvers and semi-autos (without under barrel lights/lasers)
- Non-slip material on mounting platform for added stability
- Universal-fit holster accommodates most handguns

PART NUMBER	DESCRIPTION	COLOR	MSRP
40BH00BK	Nylon Bedside Holster	Black	\$35.95



NYLON ANKLE HOLSTER

- Constructed of 1000 denier CORDURA® nylon outer material
- Closed-cell foam padding protects pistol from moisture
- Non-stretch retention strap with molded thumb break

PART NUMBER	GUN FIT	SIZE	COLOR	MSRP
40AH00BK-L	2" Barrel Small-Frame 5-Shot Revolvers with Hammer Spur	00	Black	\$40.95
40AH00BK-R	2" Barrel Small-Frame 5-Shot Revolvers with Hammer Spur	00	Black	\$40.95
40AH01BK-L	3" - 4" Barrel Medium-Frame .32/.380 Autos	01	Black	\$40.95
40AH01BK-R	3" - 4" Barrel Medium-Frame .32/.380 Autos	01	Black	\$40.95
40AH10BK-L	Small Autos (.22/.25) and Very Small-Frame .32 and .380s	10	Black	\$40.95
40AH10BK-R	Small Autos (.22/.25) and Very Small-Frame .32 and .380s	10	Black	\$40.95
40AH12BK-L	Glock 26/27/33 and other Sub-Compact 9/40	12	Black	\$40.95
40AH12BK-R	Glock 26/27/33 and other Sub-Compact 9/40	12	Black	\$40.95
40AH16BK-L	3.25" - 3.75" Barrel Medium/Large Autos	16	Black	\$40.95
40AH16BK-R	3.25" - 3.75" Barrel Medium/Large Autos	16	Black	\$40.95



HOLSTERS **TACTICAL**



T-SERIES L2C OVERT

- Thumb-activated retention follows Blackhawk Master Grip Principle
- Low-friction internal material for smooth, effortless draw
- Sound-dampening lining for stealth drawing and holstering
- Durable material provides protection with sleek design for minimal bulk
- Duty Rated
- Red dot sight compatible
- Made in the USA
- Available in light bearing configurations
- Optimized for tactical shooters gun belts
- Jacket Slot Belt Loop - Provides more optimal draw height with adjustable cant and clamping belt interface for added security
- Leg Strap Adapter - Provides added stability in austere and dynamic environments

PART NUMBER	GUN FIT	COLOR	SIZE	MSRP
NON LIGHT BEARING				
411700BKL	Glock 17/22/31/34/35/41/47, not Gen 5 .40	Black	00	\$99.95
411700BKR	Glock 17/22/31/34/35/41/47, not Gen 5 .40	Black	00	\$99.95
411703BKR	Colt 1911 w or w/o Rail-not all clones	Black	03	\$99.95
411707BKR	Springfield XD/XDM/Mod2	Black	07	\$99.95
411757BKR	S&W M&P 9/.40/.45, SD9/.40 & Taurus PT 24/7 Pro	Black	57	\$99.95
411761BKL	Sig P320 9/.40 ,M17/M18	Black	61	\$99.95
411761BKR	Sig P320 9/.40 ,M17/M18	Black	61	\$99.95
LIGHT BEARING				
411200BKL	Glock 17/19/22/23/31/32/45/47 w TLR 7/8, not Gen 5 .40	Black	00	\$99.95
411200BKR	Glock 17/19/22/23/31/32/45/47 w TLR 7/8, not Gen 5 .40	Black	00	\$99.95
411261BKR	Sig P320 9/.40 ,M17/M18 w/TLR 7/8	Black	61	\$99.95
411400BKL	Glock 17/19/22/23/31/32/45/47	Black	00	\$99.95
411400BKR	Glock 17/19/22/23/31/32/45/47	Black	00	\$99.95



SERPA® LEVEL 2 TACTICAL HOLSTER

- SERPA® Auto Lock™ release
- Passive retention detent adjustment screw
- Full-length holster body protects rear sights
- Flexible thigh platform conforms to leg size
- Y-harness suspension system distributes weight evenly, keeps holster vertical and allows use of pocket
- Quick-disconnect swivel buckles for quick holster mounting/dismounting
- Fits all Blackhawk injection-molded platforms

PART NUMBER	GUN FIT	SIZE	COLOR	MSRP	MTO	NSN
430500BK-L	Glock 17/19/20/21/22/23/31/32/45, not Gen 5 .40 & S&W M&P 9/.40/.45	00	Black	\$140.95		
430500BK-R	Glock 17/19/22/23/31/32/45, not Gen 5 .40	00	Black	\$140.95		
430500CT-R	Glock 17/19/22/23/31/32/45, not Gen 5 .40	00	Coyote Tan	\$140.95	MTO	1095-01-599-5853
430503BK-L	Colt 1911 Gov't & Clones w/ or w/o rail, not all Clones	03	Black	\$140.95		
430503BK-R	Colt 1911 Gov't & Clones w/ or w/o rail, not all Clones	03	Black	\$140.95		
430503CT-L	Colt 1911 Gov't & Clones w/ or w/o rail, not all Clones	03	Coyote Tan	\$140.95		
430503CT-R	Colt 1911 Gov't & Clones w/ or w/o rail, not all Clones	03	Coyote Tan	\$140.95		1095-01-599-5853
430503OD-L	Colt 1911 Gov't & Clones w/ or w/o rail, not all Clones	03	Olive Drab	\$140.95		
430503OD-R	Colt 1911 Gov't & Clones w/ or w/o rail, not all Clones	03	Olive Drab	\$140.95		
430504BK-L	Beretta 92/96/M9/M9A1 (Not Elite, Brig./92A1/96A1)	04	Black	\$140.95		
430504BK-R	Beretta 92/96/M9/M9A1 (Not Elite, Brig./92A1/96A1)	04	Black	\$140.95		1095-01-533-3010
430504CT-L	Beretta 92/96/M9/M9A1 (Not Elite, Brig./92A1/96A1)	04	Coyote Tan	\$140.95		
430504CT-R	Beretta 92/96/M9/M9A1 (Not Elite, Brig./92A1/96A1)	04	Coyote Tan	\$140.95		1095-01-533-3009
430504CT-R-USMC	Beretta 92/96/M9/M9A1 (Not Elite, Brig./92A1/96A1)	04	Coyote Tan	\$140.95		
430504CT-L-USMC	Beretta 92/96/M9/M9A1 (Not Elite, Brig./92A1/96A1)	04	Coyote Tan	\$140.95		
430504FG-L	Beretta 92/96/M9/M9A1 (Not Elite, Brig./92A1/96A1)	04	Foliage Green	\$140.95	MTO	
430504FG-R	Beretta 92/96/M9/M9A1 (Not Elite, Brig./92A1/96A1)	04	Foliage Green	\$140.95	MTO	
430504FG-L-ARMY	Beretta 92/96/M9/M9A1 (Not Elite, Brig./92A1/96A1)	04	Foliage Green	\$140.95	MTO	
430504FG-R-ARMY	Beretta 92/96/M9/M9A1 (Not Elite, Brig./92A1/96A1)	04	Foliage Green	\$140.95	MTO	
430504OD-L	Beretta 92/96/M9/M9A1 (Not Elite, Brig./92A1/96A1)	04	Olive Drab	\$140.95		
430504OD-R	Beretta 92/96/M9/M9A1 (Not Elite, Brig./92A1/96A1)	04	Olive Drab	\$140.95		
430506BK-L	Sig 220/225/226/228/229, MK25 w/ or w/o rail (not ES)	06	Black	\$140.95		
430506BK-R	Sig 220/225/226/228/229, MK25 w/ or w/o rail (not ES)	06	Black	\$140.95		
430506CT-L	Sig 220/225/226/228/229, MK25 w/ or w/o rail (not ES)	06	Coyote Tan	\$140.95	MTO	
430506CT-R	Sig 220/225/226/228/229, MK25 w/ or w/o rail (not ES)	06	Coyote Tan	\$140.95	MTO	1095-01-582-8118
430506OD-L	Sig 220/225/226/228/229, MK25 w/ or w/o rail (not ES)	06	Olive Drab	\$140.95		
430506OD-R	Sig 220/225/226/228/229, MK25 w/ or w/o rail (not ES)	06	Olive Drab	\$140.95		
430508BK-L	Sig Pro 2022	08	Black	\$140.95	MTO	
430508BK-R	Sig Pro 2022	08	Black	\$140.95	MTO	
430513BK-R	Glock 20/21/21SF (not 1913 Rail)/37/38 & S&W M&P 9/.40/.45	13	Black	\$140.95		
430526BK-R	Glock 21SF w/1913 Rail	26	Black	\$140.95	MTO	
430561BKR	Sig P320/P250 (not sub compact or P320 .45)	61	Black	\$140.95	MTO	
430561CTR	Sig P320/P250 (not sub compact or P320 .45)	61	Coyote Tan	\$140.95	MTO	
44H2500BR	Glock 17/22/31 w/X300, not Gen 5 .40	00	Black	\$90.95		
44H2500BL	Glock 17/22/31 w/X300, not Gen 5 .40	00	Black	\$90.95		



SERPA® LEVEL 3 TACTICAL HOLSTER

- SERPA® Auto Lock™ release
- Passive retention detent adjustment screw
- Thumb-activated Pivot Guard for additional security
- Full-length holster body protects rear sights
- Flexible thigh platform conforms to leg size
- Y-harness suspension system distributes weight evenly, keeps holster vertical and allows use of pocket
- Quick-disconnect swivel buckles for quick holster mounting/dismounting
- Accessory mounting points for pouches, knives, mag cases, etc.
- Rubberized leg straps eliminate sliding

PART NUMBER	GUN FIT	SIZE	COLOR	MSRP	MTO	NSN
430600BK-L	Glock 17/19/22/23/31/32/45/47, not gen 5 .40	00	Black	\$166.95		
430600BK-R	Glock 17/19/22/23/31/32/45/47, not gen 5 .40	00	Black	\$166.95		
430603BK-L	Colt 1911 Gov't & Clones w/ or w/o rail, not all clones	03	Black	\$166.95		
430603BK-R	Colt 1911 Gov't & Clones w/ or w/o rail, not all clones	03	Black	\$166.95		
430604BK-L	Beretta 92/96/M9/M9A1 (Not Elite, Brig./92A1/96A1)	04	Black	\$166.95		1095-01-599-0392
430604BK-R	Beretta 92/96/M9/M9A1 (Not Elite, Brig./92A1/96A1)	04	Black	\$166.95		1095-01-599-0391
430604FG-L	Beretta 92/96/M9/M9A1 (Not Elite, Brig./92A1/96A1)	04	Black	\$166.95	MTO	
430604FG-R	Beretta 92/96/M9/M9A1 (Not Elite, Brig./92A1/96A1)	04	Black	\$168.95	MTO	8465-01-623-7273
430606BK-L	Sig 220/225/226/228/229, MK25 w/ or w/o rail (not ES)	06	Black	\$168.95		
430606BK-R	Sig 220/225/226/228/229, MK25 w/ or w/o rail (not ES)	06	Black	\$166.95		
430607BK-L	Springfield XD/Mod.2/XDM 3.8"-4"	07	Black	\$166.95		
430607BK-R	Springfield XD/Mod.2/XDM 3.8"-4"	07	Black	\$166.95		
430608BK-L	Sig Pro 2022	08	Black	\$166.95		
430608BK-R	Sig Pro 2022	08	Black	\$166.95		
430609BK-L	H&K USP Compact / P2000 (EURO) 9/.40	09	Black	\$166.95		
430609BK-R	H&K USP Compact / P2000 (EURO) 9/.40	09	Black	\$166.95		
430610BK-L	S&W 5946	10	Black	\$166.95		
430610BK-R	S&W 5946	10	Black	\$166.95		
430614BK-L	H&K USP Full Size 9/.40	14	Black	\$166.95		
430614BK-R	H&K USP Full Size 9/.40	14	Black	\$166.95		
430616BK-L	H&K P2000 (Not P2000SK)	16	Black	\$166.95	MTO	
430616BK-R	H&K P2000 (Not P2000SK)	16	Black	\$166.95	MTO	
430617BK-L	H&K P30 (not P30SK)	17	Black	\$166.95	MTO	
430617BK-R	H&K P30 (not P30SK)	17	Black	\$166.95	MTO	
430624BK-R	Walther P99/ S&W SW99	24	Black	\$166.95	MTO	
430625BK-L	S&W M&P 9/.357 Sig/.40 & SD9/40 (not CORE)	25	Black	\$166.95		
430625BK-R	S&W M&P 9/.357 Sig/.40 & SD9/40 (not CORE)	25	Black	\$166.95		
430645BK-L	S&W M&P .45 & 9/.40 Pro w/o Thumb Safety	45	Black	\$166.95	MTO	
430645BK-R	S&W M&P .45 & 9/.40 Pro w/o Thumb Safety	45	Black	\$166.95	MTO	





MILITARY SERPA® COMBO KIT

- SERPA® Level 2 Tactical Holster
- Drop leg platform
- SERPA® Jacket Slot Belt Loop
- S.T.R.I.K.E.® Plate
- Quick-Disconnect kit

PART NUMBER	GUN FIT	SIZE	COLOR	MSRP
4305USACT-R	Beretta 92/96/M9/M9A1 (Not Elite, Brig./92A1/96A1)	05	Coyote Tan	\$247.95
4305USACT-L	Beretta 92/96/M9/M9A1 (Not Elite, Brig./92A1/96A1)	05	Coyote Tan	\$247.95
430561CTRK	Sig P320/P250 (not sub compact or P320 .45)	61	Coyote Tan	\$245.95



TACTICAL HOLSTER PLATFORM

SERPA® S.T.R.I.K.E.® COMBO KIT (BERETTA ONLY)

- Designed to fit SERPA® CQC® Concealment Holster Beretta M9/92/96 (not Elite, Brigadier or M9A1)
- Includes Tactical Holster Platform
- Includes S.T.R.I.K.E.® Platform with SERPA® Holster
- Includes Belt Loop Platform
- Includes Shoulder Harness Holster Platform (black only)
- Medium (40SC02) fits shirt size Medium to XL
- Large (40SC03) fits shirt size XL to 3XL

PART NUMBER	GUN FIT	SIZE	COLOR	MSRP
40SC03CT-R	Beretta 92/96/M9/M9A1 (Not Elite, Brig./92A1/96A1)	Large	Coyote Tan	\$225.95
40SC03CT-L	Beretta 92/96/M9/M9A1 (Not Elite, Brig./92A1/96A1)	Large	Coyote Tan	\$225.95
40SC02FG-R	Beretta 92/96/M9/M9A1 (Not Elite, Brig./92A1/96A1)	Medium	Foliage Green	\$225.95
40SC02FG-L	Beretta 92/96/M9/M9A1 (Not Elite, Brig./92A1/96A1)	Medium	Foliage Green	\$225.95
40SC02CT-R	Beretta 92/96/M9/M9A1 (Not Elite, Brig./92A1/96A1)	Medium	Coyote Tan	\$225.95
40SC02CT-L	Beretta 92/96/M9/M9A1 (Not Elite, Brig./92A1/96A1)	Medium	Coyote Tan	\$225.95



S.T.R.I.K.E.® PLATFORM WITH SERPA® HOLSTER (BERETTA ONLY)

- Ambidextrous adapter platform
- Designed to fit SERPA® CQC® Concealment Holster at any angle
- For Beretta M9/92/96 (not Elite, Brigadier or M9A1)
- Can be mounted to any S.T.R.I.K.E.® or PALS/MOLLE platform
- Holster included

PART NUMBER	GUN FIT	SIZE	COLOR	MSRP	NSN
40CL01FG-R	Beretta 92/96/M9/M9A1 (Not Elite, Brig./92A1/96A1)	01	Foliage Green	\$54.95	
40CL01FG-L	Beretta 92/96/M9/M9A1 (Not Elite, Brig./92A1/96A1)	01	Foliage Green	\$54.95	
40CL01CT-R	Beretta 92/96/M9/M9A1 (Not Elite, Brig./92A1/96A1)	01	Coyote Tan	\$54.95	1095-01-533-3014
40CL01CT-L	Beretta 92/96/M9/M9A1 (Not Elite, Brig./92A1/96A1)	01	Coyote Tan	\$54.95	1095-01-533-3012



NYLON ΩMEGA® VI IMPROVED UNIVERSAL AMBIDEXTROUS DROP LEG HOLSTER

- Ambidextrous design
- Constructed of 500 denier CORDURA® nylon
- Designed primarily for law enforcement officers
- Y-harness drop leg platform for even weight distribution
- Elastic, rubberized leg straps for stability and comfort
- Adjustable thumb break with retention strap for secure fit
- Fits most pistols with or without light or laser aiming module

PART NUMBER	GUN FIT	SIZE	COLOR	MSRP	NSN
40CL01FG-R	Beretta 92/96/M9/M9A1 (Not Elite, Brig./92A1/96A1)	01	Foliage Green	\$54.95	
40CL01FG-L	Beretta 92/96/M9/M9A1 (Not Elite, Brig./92A1/96A1)	01	Foliage Green	\$54.95	
40CL01CT-R	Beretta 92/96/M9/M9A1 (Not Elite, Brig./92A1/96A1)	01	Coyote Tan	\$54.95	1095-01-533-3014
40CL01CT-L	Beretta 92/96/M9/M9A1 (Not Elite, Brig./92A1/96A1)	01	Coyote Tan	\$54.95	1095-01-533-3012



EPOCH™ LEVEL 3 LIGHT-BEARING TACTICAL HOLSTER

- Holster carries one pistol at mid-thigh height.
- EPOCH Auto Lock thumb release (patent pending).
- Thumb-activated Pivot Guard and Ejection-Port Lock.
- Fits popular under-barrell style lights (TLR-1, TLR-2, X300 and X300U-A).
- Reinforces full master grip.
- No snaps or hoods to accidentally open.
- Flexible thigh platform conforms to leg size.
- Y-harness system distributes weight evenly and keeps holster vertical.
- Quick-disconnect swivel buckles for quick mounting/dismounting.
- Accessory mounting points for pouches, knives, magazine cases, etc.
- Comes with drop leg platform

PART NUMBER	GUN FIT	SIZE	FINISH	COLOR	MSRP	MTO
44E600BK-L	Glock 17/22/31, not Gen 5 .40	00	Matte	Black	\$166.95	
44E600BK-R	Glock 17/22/31, not Gen 5 .40	00	Matte	Black	\$166.95	
44E613BK-L	Glock 20/21/37	13	Matte	Black	\$166.95	
44E613BK-R	Glock 20/21/37	13	Matte	Black	\$166.95	
44E625BK-R	S&W M&P 9/.357 Sig/.40	25	Matte	Black	\$166.95	
44E645BK-R	S&W M&P .45	45	Matte	Black	\$166.95	MTO
44E645BK-L	S&W M&P .45	45	Matte	Black	\$166.95	MTO



NYLON SPECIAL OPERATIONS HOLSTER

- Constructed of 1000 denier CORDURA® nylon outer material
- Elastic, rubberized leg straps for stability and comfort
- Adjustable thumb break for quick draw
- Top flap covers pistol for maximum weapon retention
- Flap secured open by hook & loop or closed by side-release buckle
- Front-mounted pouch for extra magazine, knife or light
- Additional mag pouches can be mounted horizontally on belt flap (pouches not included)
- Fits most semi-auto pistols

PART NUMBER	GUN FIT	COLOR	MSRP	NSN
40XP00OD	Most Semi-Auto Pistols	Olive Drab	\$72.95	8465-01-501-8078



NYLON ΩMEGA® VI ULTRA

- For wear on a belt or any S.T.R.I.K.E.® or PALS/MOLLE platform
- Ambidextrous design
- Constructed of 1000 denier CORDURA® nylon outer material
- Elastic, rubberized leg straps for stability and comfort
- Includes Speed Clips™ and three side-release buckles for three-point breakaway
- Front-mounted pouch for extra magazine, knife or light
- Adjustable thumb break with extra hook & loop retention
- Fits most pistols with or without light or laser aiming module

PART NUMBER	DESCRIPTION	COLOR	MSRP	NSN
40MLH1OD	Nylon Omega® VI Ultra	Olive Drab	\$112.95	1095-01-566-9961
40MLH1CT	Nylon Omega® VI Ultra	Coyote Tan	\$112.95	
40MLH1BK	Nylon Omega® VI Ultra	Black	\$112.95	



NYLON ΩMEGA® VI ELITE HOLSTER

- Constructed of 1000 denier CORDURA® nylon outer material
- Elastic, rubberized leg straps for stability and comfort
- Three side-release buckles for three-point breakaway
- Front-mounted pouch for extra magazine, knife or light
- Removable retention strap
- Adjustable thumb break with extra hook & loop retention

PART NUMBER	GUN FIT	COLOR	SIZE	MSRP	NSN
40QD02BK	Glock 17/19/22/23/27/31/32 and Sig 226/228	Black	02	\$87.95	1095-01-610-0683
40QD02BK-LEFT	Glock 17/19/22/23/27/31/32 and Sig 226/228	Black	02	\$87.95	1095-01-422-1031
40QD02DE	Glock 17/19/22/23/27/31/32 and Sig 226/228	Desert Tan	02	\$87.95	
40QD02DE-LEFT	Glock 17/19/22/23/27/31/32 and Sig 226/228	Desert Tan	02	\$87.95	
40QD02OD	Glock 17/19/22/23/27/31/32 and Sig 226/228	Olive Drab	02	\$87.95	
40QD22BK	Colt 1911 .45 and Browning Hi-Power	Black		\$87.95	



HOLSTERS

PLATFORMS & ACCESSORIES



T-SERIES MODULAR DROP KIT

- Ride height and cant adjustable
- Thumb Channel for improved clearance and use with gloves
- Compatible with Jacket Slot Leg Strap Adapter
- Vertical drop platform optimized for use with the new T-Series quick detach (QD2)

PART NUMBER	DESCRIPTION	COLOR	MSRP
44H913BK	T-Series Modular Drop Kit - Low Ride	Black	\$49.95
44H914BK	T-Series Modular Drop Kit - Mid Ride	Black	\$49.95



T-SERIES QUICK DISCONNECT

- Low-profile duty-rated quick release system
- Configure your gear quickly and without tools
- Dual release buttons for extra security
- Works with all T-Series & Serpa Duty holsters
- Made in the USA

PART NUMBER	DESCRIPTION	MSRP
430953BK	T-Series Quick Detach	\$34.95



QUICK DISCONNECT SYSTEM KIT

- Allows one holster to be used on multiple platforms and easy 360-degree adjustments
- Kit includes two Female Adapters and one Male Adapter
- Holster releases by lifting the quick-disconnect tabs and turning counterclockwise

PART NUMBER	DESCRIPTION	COLOR	MSRP	NSN
430950BK	Quick Disconnect System Kit	Black	\$42.95	
430950CT	Quick Disconnect System Kit	Coyote Tan	\$42.95	5340-01-586-3499
430950FG	Quick Disconnect System Kit	Foliage Green	\$42.95	
430950OD	Quick Disconnect System Kit	Olive Drab	\$42.95	
430951BK	Quick Disconnect Male Adapter	Black	\$10.95	
430951CT	Quick Disconnect Male Adapter	Coyote Tan	\$10.95	
430951OD	Quick Disconnect Male Adapter	Olive Drab	\$10.95	8465-01-599-8920
430952BK	Quick Disconnect Female Adapter	Black	\$21.95	
430952CT	Quick Disconnect Female Adapter	Coyote Tan	\$21.95	
430952OD	Quick Disconnect Female Adapter	Olive Drab	\$21.95	8465-01-599-8922





T-SERIES MOLLE ADAPTER

- Ratcheting design accommodates various MOLLE designs
- Mount removes unwanted movement in a small footprint
- User-selectable rotation to customize position of provided T-Series Quick Detach
- Works with all T-Series & Serpa Duty holsters
- Made in the USA

PART NUMBER	DESCRIPTION	COLOR	MSRP
432500BK	T-Series MOLLE Adapter w/QD2	Black	\$39.95



2-SLOT BELT LOOP

- Designed to fit any Blackhawk injection molded holster
- Ambidextrous
- Cant adjustable for angle of draw
- Asymmetrical design tucks grip of handgun toward body for improved concealment

PART NUMBER	DESCRIPTION	COLOR	MSRP
44H910BK	T-Series 2-Slot belt loop	Black	\$19.95



T-SERIES® JACKET SLOT BELT LOOP

- Designed to fit any Blackhawk injection-molded holster
- Thumb channel for improved clearance and use with gloved hands
- Compatible with single leg strap attachments

PART NUMBER	DESCRIPTION	COLOR	MSRP
44H908BK	T-Series Jacket Slot Belt Loop	Black	\$24.95



HOLSTER SPACER KITS

- Adjust the angle or distance away from the body of any Blackhawk injection-molded holster
- Concealment Holster Spacer Kit (411400C) includes two spacers and 8-32 screws
- Tactical/Duty Holster Spacer Kit (411401C) includes one spacer and 10-32 screws

PART NUMBER	DESCRIPTION	COLOR	MSRP	NSN
411400CBK	Concealment Holster Spacer Kit	Black	\$16.95	8465-01-613-1607
411401CBK	Tactical/Duty Holster Spacer Kit	Black	\$11.95	8465-01-555-1506



QUICK DUAL RELEASE (QDR) BELT MOUNT

- Designed to fit any Blackhawk T-Series, Serpa, & Taser holster
- Duty Strength belt loop with same easy on/off as a paddle
- Dual release buttons for extra security
- Ambidextrous design
- Made In USA

PART NUMBER	DESCRIPTION	COLOR	MSRP
44H909BK	T-Series Quick Dual Release (QDR) Belt Loop	Black	\$24.95



CQC BELT LOOP PLATFORM WITH SCREWS

- Designed to fit any Blackhawk Serpa concealment holster
- Belt slot adjustment tabs allow for ride height and angle adjustment.

PART NUMBER	DESCRIPTION	COLOR	MSRP	NSN
410901BK	SERPA® Belt Loop Platform	Black	\$12.95	8465-01-599-8921





PADDLE PLATFORM WITH SCREWS

- Designed to fit any Blackhawk Serpa concealment holster

PART NUMBER	DESCRIPTION	COLOR	MSRP
410902BK	SERPA® Paddle Platform w/Screws	Black	\$14.95



MID-RIDE DUTY BELT LOOP WITH SCREWS

- Designed to fit any Blackhawk injection-molded duty holster
- Moves holster higher on duty belt
- Fits 2" and 2.25" duty belts

PART NUMBER	DESCRIPTION	COLOR	MSRP	NSN
44H902BK	Mid-Ride Duty Belt Loop	Black	\$23.95	8465-01-613-1607



SERPA® JACKET SLOT DUTY BELT LOOP WITH SCREWS

- Designed to fit any Blackhawk Serpa duty holster
- Attach holster to duty belt without unthreading other gear

PART NUMBER	DESCRIPTION	COLOR	MSRP	MTO
44H901BK	Serpa Jacket Slot Duty Belt Loop	Black	\$18.95	
44H901CT	Serpa Jacket Slot Duty Belt Loop	Coyote Tan	\$18.95	MTO



S.T.R.I.K.E.® PLATFORM

- Ambidextrous adapter platform
- Constructed with a durable injection molded polymer
- Holds rail-mounted accessories such as mag cases, light cases, knife sheaths, etc.
- Can be mounted to any S.T.R.I.K.E.® or PALS/MOLLE platform
- Does not include holster

PART NUMBER	DESCRIPTION	COLOR	MSRP	NSN
38CL63BK	S.T.R.I.K.E.® Platform	Black	\$17.95	8465-01-613-1607
38CL63CT	S.T.R.I.K.E.® Platform	Coyote Tan	\$17.95	8465-01-555-1506
38CL63FG	S.T.R.I.K.E.® Platform	Foliage Green	\$17.95	
38CL63OD	S.T.R.I.K.E.® Platform	Olive Drab	\$17.95	8465-01-599-8401



HIGH-RIDE DUTY BELT LOOP WITH SCREWS

- Designed to fit any Blackhawk Serpa duty holster
- Moves holster higher on duty belt
- Fits 2" and 2.25" duty belts

PART NUMBER	DESCRIPTION	COLOR	MSRP
44H900BK	SERPA® High-Ride Duty Belt Loop	Black	\$14.95



TACTICAL HOLSTER PLATFORM

- Flexible thigh platform conforms to leg size
- Y-harness suspension system distributes weight evenly, keeps holster vertical and allows use of pocket
- Quick-disconnect swivel buckles for quick holster mounting/dismounting
- Rubberized leg straps eliminate sliding
- Accessory mounting points for pouches, knives, mag cases, etc.
- Requires Duty Accessory Mounting Screw Kit (sold separately) for mounting Blackhawk duty gear
- Accommodates Blackhawk Injection-molded concealment or duty holsters

PART NUMBER	DESCRIPTION	COLOR	MSRP	NSN
432000PBK	Tactical Holster Platform	Black	\$76.45	8465-01-529-7438
432000POD	Tactical Holster Platform	Olive Drab	\$76.45	8465-01-529-7440
432000PCT	Tactical Holster Platform	Coyote Tan	\$76.45	8465-01-529-7439



T-SERIES JACKET SLOT LEG STRAP ADAPTER

- Enhances the Jacket Slot Belt Loop by adding the security of a single leg strap
- Rotating design maintains pistol position for an optimal draw while moving with you
- Adjustable height allows user to optimize ride height and reduce crowding
- Uses a single 1.5" leg strap with elastic webbing woven with rubber to enhance grip and reduce movement
- Affixes to the Jacket Slot system with a provided aluminum bushing
- Made in USA

PART NUMBER	DESCRIPTION	COLOR	MSRP	NSN
432400BK	T-Series Rotating Leg Strap Adapter	Black	\$24.95	8465-01-529-7438



MICRO TACTICAL HOLSTER PLATFORM

- Low-profile drop platform with single leg strap
- Lightweight with a compact footprint
- Adjustable vertical strap allows user to optimize ride height
- 2" elastic leg strap with elastic webbing woven with rubber to enhance grip
- Made in USA

PART NUMBER	DESCRIPTION	COLOR	MSRP
432200BK	Micro Leg Platform	Black	\$89.95





SINGLE MAG CASES

- Features a built-in tension spring to securely hold magazines of various sizes
- Remove the belt clip and place two Single Mag Cases side-by-side on Dual Rail Accessory Platform
- Single-stack versions fit 9mm/.40 cal/.45 cal/10mm/.357 Sig
- Double-stack versions fit 9mm/.40 cal

PART NUMBER	DESCRIPTION	COLOR	FINISH	MSRP	MTO	NSN
410500PBK	Single Stack	Black	Matte	\$23.95		
410500PCT	Single Stack	Coyote Tan	Matte	\$23.95		
410500POD	Single Stack	Olive Drab	Matte	\$23.95	MTO	
410600CBK	Double Stack	Black	Carbon Fiber	\$24.95		
410600PBK	Double Stack	Black	Matte	\$23.95		8465-01-529-7485
410600PCT	Double Stack	Coyote Tan	Matte	\$23.95		
410600POD	Double Stack	Olive Drab	Matte	\$23.95		1305-01-622-6330



TACTICAL MAG POUCH

- High-strength proprietary polymer construction
- Molded flap with snap retains magazine
- Mounts directly to tactical holster platforms (sold separately)

PART NUMBER	DESCRIPTION	COLOR	MSRP	MTO	NSN
430900BK	Tactical Mag Pouch w/flap - Single or Double Stack	Black	\$23.95		
430900CT	Tactical Mag Pouch w/flap - Single or Double Stack	Coyote Tan	\$23.95		8465-01-623-7274
430900OD	Tactical Mag Pouch w/flap - Single or Double Stack	Olive Drab	\$23.95	MTO	



DOUBLE MAG CASES

- Built-in tension spring securely holds magazines of various sizes
- Includes belt loops and belt clip
- Curved to waistline for slimmer profile
- Single-stack versions fit 9mm/.40 cal/.45 cal/10mm/.357 Sig
- Double stack fitment

PART NUMBER	DESCRIPTION	COLOR	FINISH	MSRP	NSN
410510CBK	Single Stack	Black	Carbon Fiber	\$37.95	
410510PBK	Single Stack	Black	Matte	\$32.95	
410610CBK	Double Stack	Black	Carbon Fiber	\$37.95	8465-01-529-7484
410610PBK	Double Stack	Black	Matte	\$41.95	



DUAL RAIL™ ACCESSORY PLATFORM

- High-strength proprietary Polymer construction
- Designed for weapon-mounted Picatinny rail lights such as Streamlight® TLR-1/ TLR-2 family of lights
- Removable M-3 holder
- Available in paddle or belt loop models

PART NUMBER	DESCRIPTION	COLOR	MSRP	NSN
411300CBK	Dual Rail™ Accessory Platform Belt Loop	Black	\$24.95	8465-01-530-0990
410800CBK	Dual Rail™ Accessory Platform Paddle Mount	Black	\$24.95	8465-01-530-0991



OMNIVORE THUMB PAD

- Available in two sizes
- Both size options per package
- Changes out easily

PART NUMBER	DESCRIPTION	COLOR	MSRP
4190TPMB	Omnivore Thumb Pad - Medium	Black	\$8.45
4190TPTB	Omnivore Thumb Pad - Tall	Black	\$8.45



OMNIVORE RAIL ATTACHMENT DEVICE

- Attaches with a dual screw clamping mechanism
- Mounts to most any accessory rail
- Detaches easily when needed

PART NUMBER	DESCRIPTION	COLOR	MSRP
4190RADB	Omnivore Rail Attachment Device (RAD)	Black	\$14.95



DUTY ACCESSORY MOUNT SCREW KIT FOR TACTICAL HOLSTER PLATFORM

This kit is required for mounting Blackhawk duty gear accessories onto Modular Drop-Leg or SERPA Tactical Holster platforms

PART NUMBER	DESCRIPTION	COLOR	MSRP
44AK001	Duty Accessory Mounting Screw Kit	Black	\$4.95



COMPACT LIGHT CARRIER

- Designed to hold small, personal-sized lights such as Streamlight® Scorpion®, TL-2® or TL-3®
- Button recess at bottom prevents accidental light activation
- Built-in tension device provides secure light carry
- Removable belt clip
- Can be mounted to Blackhawk Dual Rail™ Accessory Platform (sold separately)

PART NUMBER	DESCRIPTION	COLOR	FINISH	MSRP	NSN
411000CBK	Compact Light Carrier	Black	Carbon Fiber	\$23.95	
411000PBK	Compact Light Carrier	Black	Matte	\$22.95	8465-01-529-5681
411000PCT	Compact Light Carrier	Coyote Tan	Matte	\$22.95	8465-01-529-5682



SHOULDER HARNESS HOLSTER PLATFORM

- Tapered, fully adjustable web harness and an offside dual Picatinny rail platform for accessories
- Mount Blackhawk injection-molded concealment holsters to underarm platform in horizontal position
- Enables one-handed re-holstering (right or left hand)
- Medium (41SH00) fits shirt size Medium to XL and Large (41SH01) fits shirt size XL to 3XL
- Does not include holster

PART NUMBER	DESCRIPTION	COLOR	SIZE	MSRP	NSN
41SH00BK	Shoulder Harness Holster Platform	Black	Medium	\$71.45	
41SH01BK	Shoulder Harness Holster Platform	Black	Large	\$71.45	8465-01-613-1279



DEMONSTRATOR REPLICAS GUNS

- Exact size of real pistol
- Injection-molded, high-strength, glass-filled polymer

PART NUMBER	DESCRIPTION	COLOR	MSRP
44DGGL17OR	Glock 17/22/31	Orange	\$40.95
44DGB92FOR	Beretta 92/96	Orange	\$40.95

DUTY & PROTECTIVE



- ENTRY TOOLS
- PLATE CARRIERS
- LEG PLATFORMS
- LOAD BEARING GEAR
- VESTS
- POUCHES
- BELTS
- DUTY GEAR
- KNEE & ELBOW PADS



DUTY & PROTECTIVE *ENTRY TOOLS*



DYNAMIC ENTRY® ACTIVE SHOOTER HALLAGAN TOOL

- Features counter-angled friction ridges to grip breaching surfaces securely and increase bite
- Electrically non-conductive handle system is resistant to 100,000 volts AC
- Redesigned tempered stainless steel wedge and horn
- Ergonomic handle reinforces proper hand placement
- Non-sparking fork end
- Length: 24"
- Weight: 7.5 lbs.
- SPECIAL NOTE: This Blackhawk product is restricted to Emergency Response Personnel, Military, Law Enforcement and Security Personnel ONLY

PART NUMBER	DESCRIPTION	COLOR	MSRP	MTO
DE-ASHT	Active Shooter Hallagan Tool	Black	\$359.95	MTO



DYNAMIC ENTRY® MINI BREAK-N-RAKE™

- Designed in conjunction with domestic and international operators
- Electrically non-conductive handle system is resistant to 100,000 volts AC
- Can replace Special Operations Hallagan Tool in the Tactical Backpack Kit
- Easily fits in trunk of patrol or rescue vehicles
- Length: 25"
- Weight: 4.5 lbs.
- SPECIAL NOTE: This Blackhawk product is restricted to Emergency Response Personnel, Military, Law Enforcement and Security Personnel ONLY

PART NUMBER	DESCRIPTION	COLOR	MSRP	MTO
DE-MBR	Mini Break & Rake	Black	\$230.45	MTO



LEGEND

- Bus Stop
- ATM
- Car Rental
- Taxi Stand
- Bicycle Rack
- Public Restroom
- Police Information Center
- Exit

SW

OLICE

POLICE





DYNAMIC ENTRY® BREACHING SLEDGE

- Micro-metal composition for added strength and reduced spalling when struck
- Electrically non-conductive handle system is resistant to 100,000 volts AC
- Sure-grip handle system reduces the chance of slippage during operations
- Friction ridges on the wedge for added grip and stability during breaching
- Length: 22"
- Weight: 8 lbs.
- SPECIAL NOTE: This Blackhawk product is restricted to Emergency Response Personnel, Military, Law Enforcement and Security Personnel ONLY

PART NUMBER	DESCRIPTION	MSRP	NSN
DE-BS	Breaching Sledge	\$167.95	5120-01-554-2827



DYNAMIC ENTRY® BREACHER SERIES

- Tempered stainless steel wedge with counter-angled friction ridges for tool stability and gripping
- Electrically non-conductive handle system is resistant to 100,000 volts AC
- Safety-guard hand grip reduces the possibility of operator's hands slipping onto working end of tool
- Length: 14.25" (Mini Breacher), 24" (Special Ops Breacher), 30" (Standard Breacher)
- Weight: 4.7 lbs. (Mini Breacher), 5.4 lbs. (Special Ops Breacher), 6 lbs. (Standard Breacher)
- SPECIAL NOTE: This Blackhawk product is restricted to Emergency Response Personnel, Military, Law Enforcement and Security Personnel ONLY

PART NUMBER	DESCRIPTION	COLOR	MSRP	MTO	NSN
DE-MB	Mini Breacher	Black	\$261.95	MTO	
DE-SOB	Special Operations Breacher		\$261.95	MTO	
DE-TB	Breacher		\$261.95	MTO	5120-01-583-4403





DYNAMIC ENTRY® THUNDERSLEDGE™ SERIES

- Sure-grip handle system reduces slippage during operations
- Electrically non-conductive handle system is resistant to 100,000 volts AC
- Drop-forged, heat-treated carbon steel striking head
- Electrically non-conductive handle system is resistant to 100,000 volts AC
- Length: 14" (Micro), 22" (Mini) 32" (ThunderSledge)
- Weight: 4.6 lbs. (Micro), 7.5 lbs. (Mini), 12 lbs. (ThunderSledge)
- SPECIAL NOTE: This Blackhawk product is restricted to Emergency Response Personnel, Military, Law Enforcement and Security Personnel ONLY

PART NUMBER	DESCRIPTION	COLOR	MSRP	NSN
DE-MCR	Micro ThunderSledge	Black	\$95.95	
DE-MTS	Mini ThunderSledge	Black	\$95.95	5120-01-554-2847
DE-TS	DynEnt ThunderSledge	Black	\$101.95	5120-01-554-2857



DYNAMIC ENTRY® THUNDERMAUL™

- Incorporates an axe and sledge into one compact tool for diverse entry function
- Electrically non-conductive handle system is resistant to 100,000 volts AC
- Sure-grip handle system reduces slippage during operations
- Drop-forged, heat-treated carbon steel striking head
- Nick-resistant tempered blade
- Length: 21.5"
- Weight: 7.5 lbs.
- SPECIAL NOTE: This Blackhawk product is restricted to Emergency Response Personnel, Military, Law Enforcement and Security Personnel ONLY

PART NUMBER	DESCRIPTION	COLOR	MSRP	NSN
DE-TM	ThunderMaul	Black	\$101.95	4210-01-532-4603



DYNAMIC ENTRY® BREAK-N-RAKE™

- Specifically engineered for window entries
- Electrically non-conductive handle system is resistant to 100,000 volts AC
- Military-grade steel serrated blade and laser-cut hook
- Three carbon steel 12" raking fins to clear away glass and other debris
- Reinforced hook removes curtains, blinds and other obstructions
- Length: 51" (DE-BR)
- Weight: 9.6 lbs. (DE-BR)
- SPECIAL NOTE: This Blackhawk product is restricted to Emergency Response Personnel, Military, Law Enforcement and Security Personnel

PART NUMBER	DESCRIPTION	COLOR	MSRP	MTO	NSN
DE-BR	Break-N-Rake	Black	\$388.95	MTO	4210-01-583-8001



DYNAMIC ENTRY® MOBILE HOME DOOR BREACHER

- Designed for outward-opening mobile home doors
- Electrically non-conductive handle system is resistant to 100,000 volts AC
- Unique leverage orientation pulls locking mechanism free of doorjamb while opening door
- Reinforced, laser-cut carbon steel head
- Length: 28.5"
- Weight: 5.5 lbs.
- SPECIAL NOTE: This Blackhawk product is restricted to Emergency Response Personnel, Military, Law Enforcement and Security Personnel ONLY

PART NUMBER	DESCRIPTION	COLOR	MSRP	MTO	NSN
DE-MHB	Mobile Home Door Breacher	Black	\$249.45	MTO	4210-01-583-8001





DYNAMIC ENTRY® DYNAMIC DUO™ KIT

- Includes Dynamic Entry® Breacher
- Includes Dynamic Entry® ThunderSledge™
- Includes Dynamic Entry® Dynamic Duo Quiver
- Length: 32"
- Weight: 18 lbs
- SPECIAL NOTE: This Blackhawk product is restricted to Emergency Response Personnel, Military, Law Enforcement and Security Personnel ONLY

PART NUMBER	DESCRIPTION	COLOR	MSRP	MTO
DE-DD	Dynamic Duo Kit	Black	\$388.95	MTO
DE-DDQ-USA	Dynamic Duo Quiver (Quiver only)	Black	\$38.45	MTO



DYNAMIC ENTRY® U.K. HALLAGAN TOOL

- Unique glass-buster head for "break and rake" operations
- Safety-guard hand grip reduces the possibility of operator's hands slipping onto working end of tool
- Tempered stainless steel wedge with counter-angled friction ridges for stability and slippage prevention
- Wedge: 2" x 4"
- Length: 32.5"
- Weight: 7.5 lbs.
- SPECIAL NOTE: This Blackhawk product is restricted to Emergency Response Personnel, Military, Law Enforcement and Security Personnel ONLY

PART NUMBER	DESCRIPTION	COLOR	MSRP	MTO	NSN
DE-UKHT	U.K. Hallagan Tool	Black	\$345.45	MTO	4210-01-517-7056



DYNAMIC ENTRY® NON-SPARKING, ELECTRICALLY NON-CONDUCTIVE HALLAGAN TOOL SERIES

- Ergonomic handle reinforces proper hand placement
- Electrically non-conductive handle system is resistant to 100,000 volts AC
- Fork and horn end for prying and breaching
- Use with Dynamic Entry® ThunderSledge™ tools to effectively breach padlocks
- Length: 24" (Special Operations), 29.5" (Standard), 40" (Gorilla Bar)
- Weight: 7.5 lbs. (Special Operations), 8 lbs. (Standard), 17.5 lbs. (Gorilla Bar)
- SPECIAL NOTE: This Blackhawk product is restricted to Emergency Response Personnel, Military, Law Enforcement and Security Personnel ONLY
- NOTE: The non-sparking alloy used in these tools is not intended for use on steel doors and frames. If breaching steel doors Dynamic Entry® recommends using one of our stainless steel tools, such as the Stainless HallaganTool™

PART NUMBER	DESCRIPTION	COLOR	MSRP	NSN
DE-SOHT	Special Operations Hallagan Tool	Black	\$347.95	5120-01-507-1498
DE-HT	Hallagan Tool	Black	\$230.45	5120-01-579-9042
DE-GB	Gorilla Bar	Black	\$338.45	5120-01-604-1153





DYNAMIC ENTRY® SPECIAL OPERATIONS ENTRY RAM

- Ergonomic control-flex handle system reduces impact stress
- Electrically non-conductive handle system is resistant to 100,000 volts AC
- Ambidextrous handle orientation for one- or two-person operation
- Forward-weighted design is a close-quarter alternative to the MonoShock Ram™
- Length: 25"
- Weight: 30 lbs.
- SPECIAL NOTE: This Blackhawk product is restricted to Emergency Response Personnel, Military, Law Enforcement and Security Personnel ONLY

PART NUMBER	DESCRIPTION	COLOR	MSRP
DE-SOER	Special Operations Entry Ram	Black	\$359.95



DYNAMIC ENTRY® MONOSHOCK™ RAM

- Ergonomic control-flex handle system reduces impact stress
- Electrically non-conductive handle system is resistant to 100,000 volts AC
- Includes padded quick-release sling
- Length: 31.5"
- Weight: 32 lbs.
- SPECIAL NOTE: This Blackhawk product is restricted to Emergency Response Personnel, Military, Law Enforcement and Security Personnel ONLY

PART NUMBER	DESCRIPTION	COLOR	MSRP	NSN
DE-MS	MonoShock Ram	Black	\$412.95	4210-01-517-7055



DYNAMIC ENTRY® CQB™ RAM

- Oversized control-flex handle system keeps breachers outside the "fatal funnel" even in cramped areas
- Electrically non-conductive handle system is resistant to 100,000 volts AC
- Length: 20"
- Weight: 23 lbs.
- SPECIAL NOTE: This Blackhawk product is restricted to Emergency Response Personnel, Military, Law Enforcement and Security Personnel ONLY

PART NUMBER	DESCRIPTION	COLOR	MSRP	NSN
DE-CQB	CQB Ram	Black	\$324.95	4210-01-522-1018



DYNAMIC ENTRY® TWIN TURBO™

- Designed for one- or two-person operation
- Electrically non-conductive handle system is resistant to 100,000 volts AC
- Ergonomic control-flex handle system reduces impact stress
- Includes padded quick-release sling
- Length: 40"
- Weight: 41.5 lbs.
- SPECIAL NOTE: This Blackhawk product is restricted to Emergency Response Personnel, Military, Law Enforcement and Security Personnel ONLY

PART NUMBER	DESCRIPTION	COLOR	MSRP	MTO	NSN
DE-TT	Twin Turbo	Black	\$629.45	MTO	4210-01-517-7054



BLACKHAWK
DYNAMIC ENTRY
1-800-303-4229

1000000

SCALP



DYNAMIC ENTRY® THOR'S HAMMER

- Sure-grip handle system reduces slippage during operations
- Operator-friendly design allows it to be swung outside the "fatal funnel"
- Length: 24"
- Weight: 15.4 lbs.
- SPECIAL NOTE: This Blackhawk product is restricted to Emergency Response Personnel, Military, Law Enforcement and Security Personnel ONLY
- Not for use on steel framed doors

PART NUMBER	DESCRIPTION	COLOR	MSRP	MTO	NSN
DE-TH	Thor's Hammer	Black	\$389.95	MTO	4210-01-598-8932



DYNAMIC ENTRY® BOLTMASTER™ SERIES

- Heat-treated cutting edges
- Lightweight and durable, each head features a tension adjustment
- Electrically non-conductive handle system is resistant to 100,000 volts AC
- Safety-guard hand grip reduces the possibility of operator's hands slipping onto working end of tool
- For use on security chains, chain link fences and non-case-hardened locks
- Jaw opening: 3/8" (Mini), 3/8" (BoltMaster), 7/16" (Super)
- Length: 18" (Mini), 24" (BoltMaster), 30" (Super)
- Weight: 5.15 lbs. (Mini), 5.75 lbs. (BoltMaster), 8 lbs. (Super)
- SPECIAL NOTE: This Blackhawk product is restricted to Emergency Response Personnel, Military, Law Enforcement and Security Personnel ONLY
- Not intended for use on hardened steel

PART NUMBER	DESCRIPTION	COLOR	MSRP	NSN
DE-BM	BoltMaster	Black	\$239.50	5110-01-534-0120
DE-MBM	Mini BoltMaster	Black	\$239.95	
DE-SBM	Super BoltMaster	Black	\$401.95	5110-01-532-4999



DYNAMIC ENTRY® PADLOCK BUSTER

- Designed for situations where the BoltMaster™ is not recommended
- Electrically non-conductive handle system is resistant to 100,000 volts AC
- Classic duckbill design for use on various padlock sizes
- Constructed of military-grade AR400 steel
- Length: 24.25"
- Weight: 6.3 lbs.
- SPECIAL NOTE: This Blackhawk product is restricted to Emergency Response Personnel, Military, Law Enforcement and Security Personnel ONLY

PART NUMBER	DESCRIPTION	COLOR	MSRP	MTO
DE-PB	Padlock Buster	Black	\$230.45	MTO



POLICE

LENCO



POLICE DEPARTMENT



DYNAMIC ENTRY® MANUAL ENTRY TOOL PACK (PACK ONLY)

- Constructed of durable 1000 denier nylon and heavily padded with closed-cell foam
- Retention straps hold tools securely in individual pouches
- Fully adjustable chest and waist straps
- Carries BoltMaster; Special Operations Hallagan Tool or Special Operations Breacher; and ThunderMaul™ or Mini ThunderSledge™

PART NUMBER	DESCRIPTION	COLOR	MSRP	NSN
60ME00BK	Manual Entry Tool Pack	Black	\$140.45	8465-01-533-5371



DYNAMIC ENTRY® TACTICAL BACKPACK KIT

- Includes Dynamic Entry® BoltMaster™ (DE-BM)
- Includes Dynamic Entry® ThunderMaul™ (DE-TM)
- Includes Dynamic Entry® Special Operations Hallagan Tool (DE-SOHT)
- Includes Dynamic Entry® Manual Entry Tool Pack (60ME00BK)
- SPECIAL NOTE: This Blackhawk product is restricted to Emergency Response Personnel, Military, Law Enforcement and Security Personnel ONLY

PART NUMBER	DESCRIPTION	COLOR	MSRP	MTO
DE-TBK	Tactical Backpack Kit	Black	\$699.45	
DE-TBKSSHT	Tactical Backpack Kit w/Stainless Steel Hallagan (Loose)	Black	\$899.95	MTO



DYNAMIC ENTRY® TACTICAL BACKPACK KIT-B

- Includes Dynamic Entry® BoltMaster™ (DE-BM)
- Includes Dynamic Entry® ThunderMaul™ (DE-TM)
- Includes Dynamic Entry® Special Operations Breacher (DE-SOB)
- Includes Dynamic Entry® Manual Entry Tool Pack (60ME00BK)
- SPECIAL NOTE: This Blackhawk product is restricted to Emergency Response Personnel, Military, Law Enforcement and Security Personnel ONLY

PART NUMBER	DESCRIPTION	COLOR	MSRP
DE-TBK-B	Tactical Backpack Kit B	Black	\$687.45



DYNAMIC ENTRY® TACTICAL BACKPACK KIT-C

- Includes Dynamic Entry® BoltMaster™ (DE-BM)
- Includes Dynamic Entry® ThunderMaul™ (DE-TM)
- Includes Dynamic Entry® Active Shooter Hallagan Tool (DE-ASHT)
- Includes Dynamic Entry® Manual Entry Tool Pack (60ME00BK)
- SPECIAL NOTE: This Blackhawk product is restricted to Emergency Response Personnel, Military, Law Enforcement and Security Personnel ONLY

PART NUMBER	DESCRIPTION	COLOR	MSRP
DE-TBK-C	Tactical Backpack Kit C	Black	\$719.95



DYNAMIC ENTRY® U.K. M.O.E.® TOOL PACK (PACK ONLY)

- Fully adjustable shoulder, waist and under-the-leg straps keep pack anchored to operator's body
- Two large retention flaps
- SPECIAL NOTE: This Blackhawk product is restricted to Emergency Response Personnel, Military, Law Enforcement and Security Personnel ONLY

PART NUMBER	DESCRIPTION	COLOR	MSRP	MTO
990662BK	U.K. M.O.E. Tool Pack	Black	\$174.95	MTO



DYNAMIC ENTRY® U.K. M.O.E.® BACKPACK KIT

- Designed for Special Forces units worldwide
- Includes Dynamic Entry® Super BoltMaster™ (DE-SBM)
- Includes Dynamic Entry® CQB Ram™ (DE-CQB)
- Includes Dynamic Entry® U.K. Hallagan Tool (DE-UKHT)
- Includes Dynamic Entry® U.K. M.O.E.™ Tool Pack (990662BK)
- SPECIAL NOTE: This Blackhawk product is restricted to Emergency Response Personnel, Military, Law Enforcement and Security Personnel ONLY

PART NUMBER	DESCRIPTION	COLOR	MSRP	NSN
DE-UKMOEK	U.K. M.O.E. Backpack Kit	Black	\$1,118.45	4210-01-572-5019



DYNAMIC ENTRY® MODULAR BACKPACK

- Integrates S.T.R.I.K.E.® webbing, Speed Clip™ devices and Dynamic Entry Modular Attachment System
- Constructed of durable 1000 denier nylon
- Lumbar padding and wide shoulder straps for maximum comfort
- Large tear-resistant, kydex-lined tool pouch with reinforced drain holes
- Modular retention straps for quick and secure mission specific tool configurations
- Includes assortment of various sized modular retention straps
- SPECIAL NOTE: This Blackhawk product is restricted to Emergency Response Personnel, Military, Law Enforcement and Security Personnel ONLY

PART NUMBER	DESCRIPTION	COLOR	MSRP	MTO
DE-MBP	Modular Backpack	Black	\$239.95	MTO



DYNAMIC ENTRY® MINI DEPLOYMENT KIT

- Includes Dynamic Entry® Mini Breacher (DE-MB)
- Includes Dynamic Entry® Micro ThunderSledge™ (DE-MCR)
- Includes Dynamic Entry® Mini BoltMaster™ (DE-MBM)
- Includes Dynamic Entry® Mini Deployment Bag (60ME03BK)
- SPECIAL NOTE: This Blackhawk product is restricted to Emergency Response Personnel, Military, Law Enforcement and Security Personnel ONLY

PART NUMBER	DESCRIPTION	COLOR	MSRP
DE-MDK	Mini Deployment Kit	Black	\$599.95



DYNAMIC ENTRY® MINI TOOL KIT

- Includes Speed Clips™
- Includes Dynamic Entry® Mini Breacher (DE-MB)
- Includes Dynamic Entry® Micro ThunderSledge™ (DE-MCR)
- Includes Dynamic Entry® Mini BoltMaster™ (DE-MBM)
- Includes two Dynamic Entry® Single Tool Carriers (5100856BK)
- Includes Dynamic Entry® Mini BoltMaster™ Pouch (5100880BK)
- SPECIAL NOTE: This Blackhawk product is restricted to Emergency Response Personnel, Military, Law Enforcement and Security Personnel ONLY

PART NUMBER	DESCRIPTION	COLOR	MSRP	MTO
DE-MTK	Mini Tool Kit	Black	\$719.95	MTO







DYNAMIC ENTRY® ENTRY KIT #1

- Includes Dynamic Entry® MonoShock Ram™ (DE-MS)
- Includes Dynamic Entry® Dynamic Duo™ (DE-DD)
- SPECIAL NOTE: This Blackhawk product is restricted to Emergency Response Personnel, Military, Law Enforcement and Security Personnel ONLY

PART NUMBER	DESCRIPTION	COLOR	MSRP	MTO
DE-EK1	Entry Kit #1	Black	\$803.45	MTO



DYNAMIC ENTRY® ENTRY KIT #2

- Combines the MonoShock Ram™ and Break-N-Rake™ with the Tactical Backpack Kit
- Includes Dynamic Entry® MonoShock Ram™ (DE-MS)
- Includes Dynamic Entry® Break-N-Rake™ (DE-BR)
- Includes Dynamic Entry® Tactical Backpack Kit-B (DE-TBK-B)
- SPECIAL NOTE: This Blackhawk product is restricted to Emergency Response Personnel, Military, Law Enforcement and Security Personnel ONLY

PART NUMBER	DESCRIPTION	COLOR	MSRP	MTO
DE-EK2	Entry Kit #2	Black	\$1,272.95	MTO



DYNAMIC ENTRY® COLLAPSIBLE MINI THUNDERSLEDGE™

- Compact collapsible design for close-quarter operations and easy transport
- 6-lb. drop-forged head is custom-designed to deliver exceptional striking force when extended
- Epoxied fiberglass core surrounded by two interlocking stainless steel shafts
- Dual-locking mechanism secures shafts when extended
- Hand grip provides secure grip in extreme weather conditions and protects locking mechanism
- Length: 14.5" (collapsed), 22" (extended) Weight: 10.2 lbs.
- SPECIAL NOTE: This Blackhawk product is restricted to Emergency Response Personnel, Military, Law Enforcement and Security Personnel ONLY

PART NUMBER	DESCRIPTION	COLOR	MSRP	MTO
DE-CMTS	Collapsible Mini ThunderSledge	Black	\$503.95	MTO



DYNAMIC ENTRY® ENTRY KIT #3

- Includes Dynamic Entry® MonoShock Ram™ (DE-MS)
- Includes Dynamic Entry® Dynamic Duo™ (DE-DD)
- Includes Dynamic Entry® Break-N-Rake™ (DE-BR)
- Includes Dynamic Entry® Mobile Home Door Breacher (DE-MHB)
- Includes Dynamic Entry® Tactical Backpack Kit-B (DE-TBK-B)
- SPECIAL NOTE: This Blackhawk product is restricted to Emergency Response Personnel, Military, Law Enforcement and Security Personnel ONLY

PART NUMBER	DESCRIPTION	COLOR	MSRP	MTO
DE-EK3	Entry Kit #3	Black	\$2,141.45	MTO



DYNAMIC ENTRY® SMALL PRY™

- Collaborative effort between Blackhawk®'s Dynamic Entry and Knife design teams
- Combines specialized prying capabilities with a readily available cutting edge
- Ideal for prying interior doors and drawers, window "break and rake" operations and tactical cutting
- Blade length: 4.390"/112mm Overall length: 14.460"/367mm
- Corrosion-resistant black epoxy powder coating on D-2 tool steel blade
- Natural-gas-valve cutoff slot: 1.5"L x .6"W (15DE00YL only)
- S.T.R.I.K.E.® mounting kit (15DE00BK-STRIKE) for attaching to PALS/MOLLE webbing
- SPECIAL NOTE: This Blackhawk product is restricted to Emergency Response Personnel, Military, Law Enforcement and Security Personnel ONLY

PART NUMBER	DESCRIPTION	COLOR	MSRP	MTO
15DE00BK-STRIKE	Small Pry w/S.T.R.I.K.E.® Mounting Kit	Black	\$209.95	MTO



DUTY & PROTECTIVE **PLATE CARRIERS**



FOUNDATION SERIES PLATE CARRIER

- Durable, yet flexible 1000D to 500D laminate material
- Lightweight and low profile laser cut MOLLE design
- Elastic cummerbund for superior comfort and flexibility
- Compatible with various placards to suit user needs
- Removable front buckles, modular from OVERT to COVERT

PART NUMBER	DESCRIPTION	COLOR	SIZE	MSRP
37FS01BK	Foundation Series Plate Carrier	Black	SM/MD	\$149.95
37FS02BK	Foundation Series Plate Carrier	Black	MD/LG	\$149.95



S.T.R.I.K.E.® CUTAWAY PLATE CARRIER

- Simple construction for quick attachment and detachment (cutaway can be easily disabled)
- Constructed of 500 denier CORDURA® nylon (MultiCam®) or 500 denier ripstop nylon (solid colors)
- Front shoulder panel quick-release strap with rounded handle under protective nylon band
- Heavy-duty drag handle
- Adjustable waist and shoulder system for tailored girth and torso fit
- Multiple rows of S.T.R.I.K.E.® webbing for attaching pouches, holsters or accessories
- Front plate pocket with inverted "T" elastic keeper accommodates bib when plates are not in use
- Ambidextrous design

PART NUMBER	DESCRIPTION	COLOR	MSRP	MTO	NSN
32V701CT	S.T.R.I.K.E.® CUTAWAY PLATE CARRIER	Coyote Tan	\$255.95	MTO	8470-01-578-7060





LOW VIS PLATE CARRIER

- Lightweight, close-fitting design
- Constructed of 500 denier CORDURA® nylon (MultiCam®) or 500 denier ripstop nylon (solid colors)
- Slim enough to be worn under clothes for low visibility
- Adjustable shoulder and side straps (one size fits all)
- Side-release buckles for quick donning and doffing
- Front hook & loop panel for ID patch
- SM/MD version accommodates plates up to 9.5" x 12.5"
- LG/XL version accommodates plates up to 10.5" x 13.25"

PART NUMBER	DESCRIPTION	COLOR	SIZE	MSRP
32PC08BK	Low Vis Plate Carrier	Black	SM/MD	\$50.95
32PC08CT	Low Vis Plate Carrier	Coyote Tan	SM/MD	\$50.95
32PC12BK	Low Vis Plate Carrier	Black	LG/XL	\$50.95
32PC12CT	Low Vis Plate Carrier	Coyote Tan	LG/XL	\$50.95



S.T.R.I.K.E.® SPEAR BALCS CUTAWAY ARMOR CARRIER

- Internal nylon lining for sleek profile and comfortable wear
- Non-Slip material on shoulders for weapon retention
- Remove the carrier in approximately 2.5 seconds and reassemble in less than a minute
- Front shoulder panel quick-release strap with rounded handle under protective nylon band
- Adjustable waist and shoulder system for tailored girth and torso fit
- Heavy-duty drag handle
- Multiple rows of S.T.R.I.K.E.® webbing for attaching pouches, holsters or accessories
- Accommodates Blackhawk Removable Side Plate Carrier and Ballistic Collar, Yoke, Biceps, Groin and Drop Leg

PART NUMBER	DESCRIPTION	COLOR	SIZE	MSRP	MTO
32SB401BK	S.T.R.I.K.E.® SPEAR BALCS CUTAWAY ARMOR CARRIER	Black	SM	\$255.95	MTO
32SB402BK	S.T.R.I.K.E.® SPEAR BALCS CUTAWAY ARMOR CARRIER	Black	MD	\$255.95	MTO
32SB403BK	S.T.R.I.K.E.® SPEAR BALCS CUTAWAY ARMOR CARRIER	Black	LG	\$255.95	MTO
32SB404BK	S.T.R.I.K.E.® SPEAR BALCS CUTAWAY ARMOR CARRIER	Black	XL	\$255.95	MTO



S.T.R.I.K.E.® COMMANDO RECON CHEST HARNESS

- Cross-back design
- Shoulder straps with closed-cell foam padding
- Heavy-duty D-rings and elastic webbing loops for securing external items
- Multiple rows of S.T.R.I.K.E.® webbing for attaching pouches, holsters or accessories
- Front plate pocket with inverted "T" elastic keeper accommodates bib when plates are not in use
- Accommodates plates up to 10.5" x 13.25"
- Accommodates S.T.R.I.K.E.® Commando Recon Back Panel for full torso rig
- Dimensions (Regular): 24" x 9" (body), 9" x 7" (bib), 69" (girth)
- Weight : 2.1 lbs.

PART NUMBER	DESCRIPTION	COLOR	MSRP
37CL01BK	S.T.R.I.K.E.® Commando Recon Chest Harness	Black	\$132.95



S.T.R.I.K.E.® LIGHTWEIGHT PLATE CARRIER HARNESS

- Constructed of 500 denier ripstop nylon
- Multiple rows of S.T.R.I.K.E.® webbing for attaching pouches, holsters or accessories
- Heavy-duty drag handle
- Dual-adjust side-release buckles for fit adjustment
- SM/MD version accommodates plates up to 9.5" x 12.5
- LG/XL version accommodates plates up to 10.5" x 13.25"
- Weight (SM/MD): 1.3 lbs.
- Weight (LG/XL): 1.5 lbs.

PART NUMBER	DESCRIPTION	COLOR	SIZE	MSRP
37CL83BK	S.T.R.I.K.E.® Lightweight Plate Carrier Harness	Black	SM/MD	\$153.45
37CL83CT	S.T.R.I.K.E.® Lightweight Plate Carrier Harness	Coyote Tan	SM/MD	\$153.45
37CL84BK	S.T.R.I.K.E.® Lightweight Plate Carrier Harness	Black	LG/XL	\$153.45
37CL84CT	S.T.R.I.K.E.® Lightweight Plate Carrier Harness	Coyote Tan	LG/XL	\$153.45



ΩMEGA ELITE® DUMP POUCH

- Constructed of 1000 denier nylon
- IVS™ (Intercooler Venting System) back panel for ventilation
- Drainage grommets in bottom of pouches
- Designed to carry loose ordinance, empty magazines, evidence or contraband
- High-quality YKK® zippers and top hook & loop flap with heavy-duty elastic for secure carry
- Heavy-duty D-rings for shoulder strap attachment
- 3" x 6" front accessory pouch with side-release buckle and hook & loop closure
- Dimensions: 9"H x 5.75"W x 4.5"D

PART NUMBER	DESCRIPTION	COLOR	MSRP	NSN
56DP00DE	Omega Elite® Dump Pouch	Coyote Tan	\$66.45	8465-01-578-7072





DUTY & PROTECTIVE **LEG PLATFORMS**



MODULAR DROP LEG PLATFORM

- Constructed of high-density polymer for comfort and flexibility
- Y-harness configuration with heavy-duty hanger straps and quick-release buckles
- Dual non-slip BTS™ belt loops
- Removable 1.5" non-slip upper leg strap and 2" non-slip lower leg strap for maximum stability
- Ventilated for increased airflow
- Four adjustable accessory rails hold four pouches, mag/light carriers or duty gear accessories

PART NUMBER	DESCRIPTION	COLOR	MSRP
432300PBK	Modular Drop-Leg Platform	Black	\$74.95



S.T.R.I.K.E.® DROP LEG PLATFORM

- Constructed of 1000 denier nylon
- Five rows of S.T.R.I.K.E.® webbing for attaching pouches or accessories
- Elastic rubberized leg straps for stability and comfort
- Dimensions: 10"H x 9"W

PART NUMBER	DESCRIPTION	COLOR	MSRP	MTO	NSN
37CL39BK	S.T.R.I.K.E.® Drop-Leg Platform	Black	\$61.45		
37CL39CT	S.T.R.I.K.E.® Drop-Leg Platform	Coyote Tan	\$61.45	MTO	8465-01-559-0654



M16 "Y" THIGH RIG

- Drop leg configuration holds four M16 magazines
- Constructed of lightweight yet durable 500 denier ripstop
- Two mag pouches on front hold two M16 magazines each
- Y-configuration with heavy-duty hanger straps and quick detach swivel buckles
- Elastic rubberized leg straps for stability and comfort
- Fully adjustable lid height

PART NUMBER	DESCRIPTION	COLOR	MSRP
561604BK	M16 "Y" Thigh Rig	Black	\$66.45



ΩMEGA ELITE® ENHANCED M16 DROP LEG MAG POUCH

- Constructed of 1000 denier nylon
- IVS™ (Intercooler Venting System) back panel for ventilation
- Drainage grommets in bottom of pouches
- Pouch dividers prevent mag clatter and enhance noise discipline
- Carries four M16/M4 30-round mags

PART NUMBER	DESCRIPTION	COLOR	MSRP
561602BK	Omega Elite® Enhanced M16 Drop-Leg Mag Pouch	Black	\$66.45



ΩMEGA ELITE® M16 MAG POUCH

- Constructed of 1000 denier nylon
- IVS™ (Intercooler Venting System) back panel for ventilation
- Drainage grommets in bottom of pouches
- Carries two M16/M4 30-round magazines

PART NUMBER	DESCRIPTION	COLOR	MSRP
561601BK	Omega Elite® M16 Mag Pouch	Black	\$66.45

ΩMEGA ELITE® DROP LEG EXTENDER

- Extends gear below belt by five inches
- Attaches to drop leg holsters, pouches and rigs

PART NUMBER	DESCRIPTION	COLOR	MSRP	NSN
56DLE2BK	Omega Elite® Drop-Leg Extender	Black	\$11.45	8465-01-564-6256





ΩMEGA ELITE® MODULAR DROP LEG MEDICAL POUCH

- Constructed of 1000 denier nylon
- IVS™ (Intercooler Venting System) back panel for ventilation
- Drainage grommets in bottom of pouches
- Securely mounts to thigh, belt or vest
- Dimensions: 7.75"H x 6.75"W x 2"D

PART NUMBER	DESCRIPTION	COLOR	MSRP	NSN
56MP00BK	Omega Elite® Modular Drop-Leg Medical Pouch	Black	\$66.45	6545-01-504-3085



ΩMEGA ELITE® GAS MASK POUCH

- Constructed of 1000 denier nylon
- IVS™ (Intercooler Venting System) back panel for ventilation
- Drainage grommets in bottom of pouches
- Adjustable, removable shoulder strap
- Heavy-duty drop leg hanger with BTS™ belt loops
- Side-release buckles and hook & loop closure
- Dimensions: 9.75"H x 6.25"W x 5"D

PART NUMBER	DESCRIPTION	COLOR	MSRP	NSN
56GM00BK	Omega Elite® Gas Mask Pouch	Black	\$66.45	4210-01-504-3082



ULTRALIGHT ΩMEGA ELITE® GAS MASK POUCH

- Constructed of lightweight 500 denier ripstop nylon
- Adjustable, removable shoulder strap and non-slip leg straps
- Y-harness configuration with heavy-duty hanger straps and quick-release swivel buckles
- Side-release buckles and hook & loop closure
- Dual non-slip BTS™ belt loops
- 1/8" padded back
- Dimensions: 11"H x 5"- 7.25"W x 4"D
- Cuff pouch: 4"H x 2.25"- 4.5"W

PART NUMBER	DESCRIPTION	COLOR	MSRP
56GM03BK	Omega Elite® Gas Mask Pouch-Ultralight	Black	\$76.95



DUTY & PROTECTIVE LOAD BEARING GEAR



SHOWN FLAT MOLLE PLACARD NOT INCLUDED

FOUNDATION SERIES CHEST RIG

- Durable, yet flexible 1000D to 500D laminate material
- One piece laser cut design has fewer breaking points
- Easily change placards with side release buckles and hook & Loop
- Slim tuck straps, adjustable for wide array of body types
- Hook and Loop panel on rear surface for unit identification
- Chest Rig does not come with a placard

PART NUMBER	DESCRIPTION	COLOR	SIZE	MSRP
37FS10BK	Foundation Series Chest Rig	Black	One Size	\$54.95



FOUNDATION SERIES PLACARD FIRST RESPONDER

- Durable, yet flexible 1000D to 500D laminate material
- Lightweight and low profile laser cut MOLLE design
- Elastic side panel construction offers multifit capability
- Middle located, rapid access Micro IFAK
- Triple 5.56 Magazine divider insert included
- Side buckles removeable for use between Plate Carrier and Chest Rig

PART NUMBER	DESCRIPTION	COLOR	MSRP
37FS13BK	Foundation Placard First Responder	Black	\$59.95





FOUNDATION SERIES PLACARD MOLLE W/ KANGAROO

- Durable, yet flexible 1000D to 500D laminate material
- Lightweight and low profile laser cut MOLLE design
- User customizable with MOLLE compatible Pouches
- Kangaroo pouch allows for Blackhawk Magazine inserts
- Triple 5.56 Magazine divider insert included
- Side buckles removeable for use between Plate Carrier and Chest Rig

PART NUMBER	DESCRIPTION	COLOR	MSRP
37FS12BK	Foundation Placard MOLLE w/ Kangaroo	Black	\$39.95

FOUNDATION SERIES INSERTS

PART NUMBER	DESCRIPTION	COLOR	MSRP
37FS16BK	Foundation Insert Pistol Magazines	Black	\$20.95
37FS17BK	Foundation Insert 5.56 Magazines	Black	\$20.95
37FS18BK	Foundation Insert 7.62 Magazines	Black	\$20.95



FOUNDATION SERIES PLACARD MOLLE FLAT

- Durable, yet flexible 1000D to 500D laminate material
- Lightweight and low profile laser cut MOLLE design
- User customizable with MOLLE compatible Pouches
- Side buckles removeable for use between Plate Carrier and Chest Rig

PART NUMBER	DESCRIPTION	COLOR	MSRP
37FS11BK	Foundation Placard MOLLE Flat	Black	\$35.95



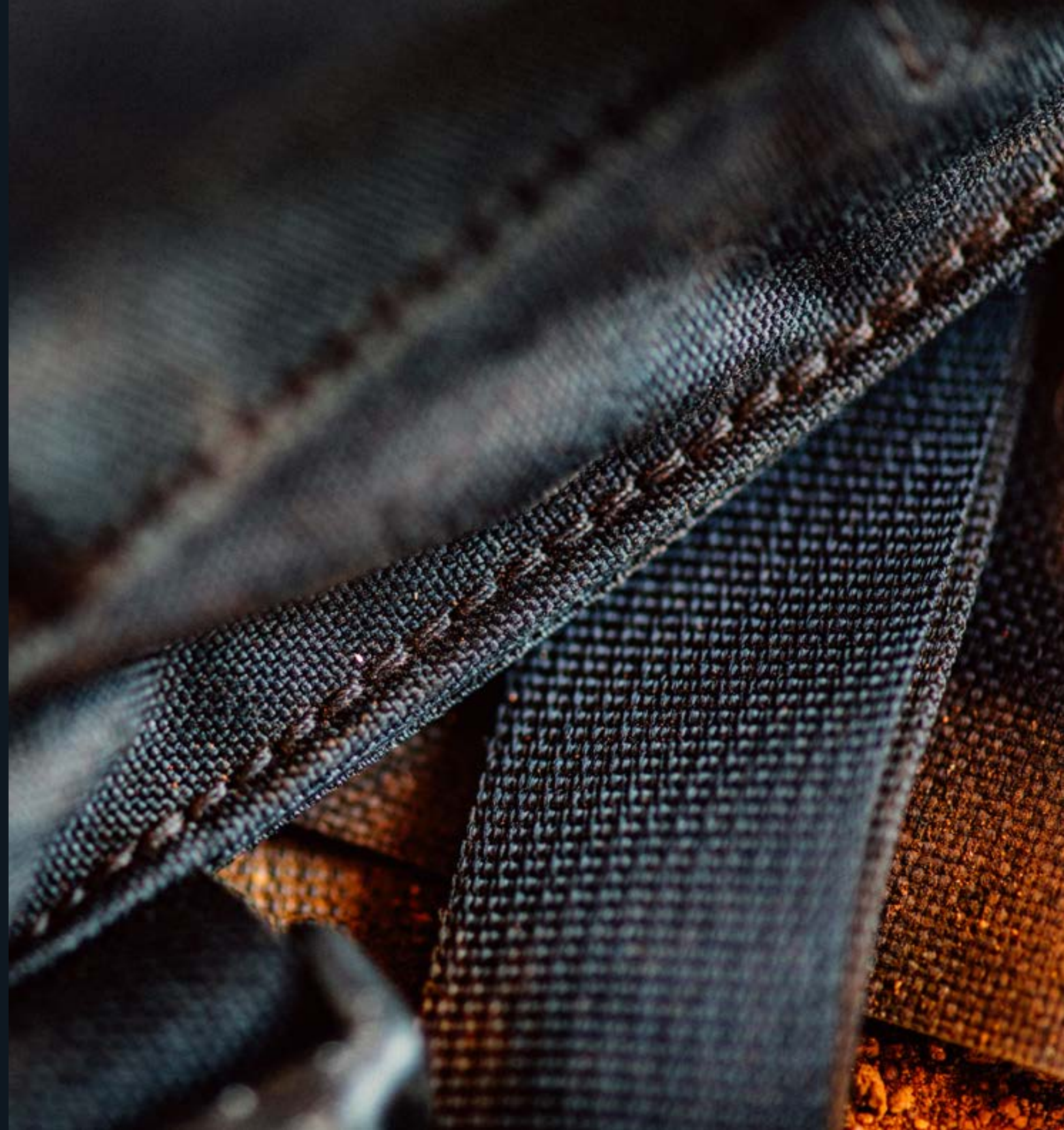

RIFLE/PISTOL BANDOLEER

- Holds four rifle magazines and two pistol magazines
- Cross-torso/shoulder-carried bandoleer with quick-release buckle for fast removal
- Padded back panel and two belt keepers on back panel secure around belt by snap fasteners
- Two M16/M4 adjustable flap mag pouches with silencing dividers in center
- Pistol mag pouches with adjustable flaps
- D-rings at bottom corners for securing to waist belt
- Dimensions: 6.5"H x 11.5"W

PART NUMBER	DESCRIPTION	COLOR	MSRP
55RB01BK	Rifle/Pistol Bandoleer	Black	\$45.95



CHEST MAGAZINE POUCH

- Constructed of durable, lightweight 500 denier ripstop and type 4 nylon webbing
- One size fits all with adjustable shoulder and waist straps
- Holds eight 30-round rifle magazines and two pistol magazines
- Pouches include grommets for drainage and hook & loop lid closures
- Available for M16/M4 (Black) and AK-47 (Coyote Tan)

PART NUMBER	DESCRIPTION	COLOR	MSRP
55CP01BK	M16/M4 Chest Magazine Pouch	Black	\$71.45
55CP04CT	AK-47 Chest Magazine Pouch	Coyote Tan	\$71.45



LOAD BEARING SUSPENDERS

- Wraparound belt loop system
- Heavy-duty drag handles and sternum strap
- No metal attachment clips
- Belt not included

PART NUMBER	DESCRIPTION	COLOR	MSRP
35LBS1BK	Load Bearing Suspenders	Black	\$40.95
35LBS1OD	Load Bearing Suspenders	Olive Drab	\$40.95



RIFLE BANDOLEER

- Holds six M16/M4 magazines
- Perfect for active shooter response
- Ambidextrous shoulder rig with non-slip pad
- Stabilizing quick-release waist strap

PART NUMBER	DESCRIPTION	COLOR	MSRP
55SOS1BK	Rifle Bandoleer	Black	\$61.45



COMMANDO CHEST HARNESS

- Durable 1000 denier nylon with adjustable, padded cross straps with .25" closed-cell foam
- Adjustable quick-release waist strap
- Four ammo pouches hold two AK-47, three M16 or two M14 magazines each
- Pouch dividers prevent magazine clatter and enhance noise discipline
- Two end utility pouches hold radios, rations, compasses, etc.
- Large internal utility/map pouch with securing flap
- Belt loops secure vest to any web belt

PART NUMBER	DESCRIPTION	COLOR	MSRP
55CO00BK	Commando Chest Harness	Black	\$148.45
55CO00DE	Commando Chest Harness	Coyote Tan	\$148.45



PATROL RADIO HARNESS

- Holds radios and other small hardware
- Internal pouch for maps and documents
- Adjustable for all portable radio sizes
- Quick-release buckles and elastic antenna support

PART NUMBER	DESCRIPTION	COLOR	MSRP	NSN
37PRH1BK	Patrol Radio Harness	Black	\$50.95	8465-01-598-9133



BORN FROM EXPERIENCE. MADE FOR THE MISSION.

DUTY & PROTECTIVE VESTS



S.T.R.I.K.E.® OMEGA™ VEST

- Adjustable for length and girth (up to 6" length and 32" girth)
- Heavy-duty YKK® zipper and side-release buckles for rapid donning and doffing
- Belt loops secure vest to web belt
- Reinforced drag handle for operator evacuation if injured
- S.T.R.I.K.E.® webbing for attaching pouches or accessories
- Constructed of durable nylon mesh for maximum breathability
- Padded non-slip shoulders for fully ambidextrous vest
- Lace-style girth adjustment
- Two Large internal zippered accessory pockets on both front panels (8.5"H x 10"W)
- Shoulder D-rings for accessory attachment

PART NUMBER	DESCRIPTION	COLOR	MSRP	NSN
37CL36BK	S.T.R.I.K.E.® Omega™ Vest	Black	\$143.45	8470-01-517-6331



S.T.R.I.K.E.® ELITE VEST

- Adjustable for length and girth (up to 6" length and 32" girth)
- Heavy-duty YKK® zipper and side-release buckles for rapid donning and doffing
- Belt loops secure vest to web belt
- Reinforced drag handle for operator evacuation if injured
- S.T.R.I.K.E.® webbing for attaching pouches or accessories
- Constructed of durable nylon mesh for maximum breathability
- Padded non-slip shoulders for fully ambidextrous vest
- Side-release buckle and web-style girth adjustment
- Shoulder D-rings for accessory attachment
- Two large internal zippered accessory pockets on both front panels (8.5"H x 10"W)

PART NUMBER	DESCRIPTION	COLOR	MSRP	NSN
37CL66BK	S.T.R.I.K.E.® Elite Vest	Black	\$168.95	
37CL66CT	S.T.R.I.K.E.® Elite Vest	Coyote Tan	\$168.95	8415-01-554-2841



OMEGA ELITE™ TACTICAL VEST #1

- Adjustable for length and girth (up to 6" length and 32" girth)
- Heavy-duty YKK® zipper and side-release buckles for rapid donning and doffing
- Belt loops secure vest to web belt
- Reinforced drag handle for operator evacuation if injured
- S.T.R.I.K.E.® webbing for attaching pouches or accessories
- Constructed of durable nylon mesh for maximum breathability
- Padded non-slip shoulders for fully ambidextrous vest
- Two Large internal zippered accessory pockets on both front panels (8.5"H x 10"W)
- Mag pouches with adjustable flaps for tall or short magazines
- Two horizontal accessory pouches
- Six M16/M4 mag pouches hold 12 magazines total
- Includes removable shotshell strip
- Hook & loop strip for I.D. Patch

PART NUMBER	DESCRIPTION	COLOR	MSRP	NSN
30EV03BK	Omega Elite™ Tactical Vest #1	Black	\$183.95	
30EV03DE	Omega Elite™ Tactical Vest #1	Coyote Tan	\$183.95	8415-01-529-7471

NEW PRODUCTS

HOLSTERS

DUTY & PROTECTIVE

APPAREL

BAGS & POUCHES

ACCESSORIES



OMEGA® PHALANX HOMELAND SECURITY VEST

- Adjustable for length and girth (up to 6" length and 32" girth)
- Heavy-duty YKK® zipper and side-release buckles for rapid donning and doffing
- Belt loops secure vest to web belt
- Reinforced drag handle for operator evacuation if injured
- S.T.R.I.K.E.® webbing for attaching pouches or accessories
- Constructed of durable nylon mesh for maximum breathability
- Padded non-slip shoulders for fully ambidextrous vest
- Two large internal zipper accessory pockets on both front panels (8.5"H x 10"W)
- Two M16/M4 pouches hold four magazines total (one has a Securing cord for radio)
- Mag pouches with adjustable flaps for tall or short magazines
- Pouches for flashbangs, handcuffs, O.C. spray and tactical light
- 14-round shotshell pouch
- Includes removable shotshell strip

PART NUMBER	DESCRIPTION	COLOR	MSRP	MTO
30EV35BK	Omega™ Phalanx Homeland Security Vest	Black	\$183.95	
30EV35CT	Omega™ Phalanx Homeland Security Vest	Coyote Tan	\$183.95	MTO



D.O.A.V. ASSAULT VEST SYSTEM

- Adjustable for length and girth (up to 6" length and 32" girth)
- Heavy-duty YKK® zipper and side-release buckles for rapid donning and doffing
- Belt loops secure vest to web belt
- Reinforced drag handle for operator evacuation if injured
- S.T.R.I.K.E.® webbing for attaching pouches or accessories
- Constructed of durable nylon mesh for maximum breathability
- Padded non-slip shoulders for fully ambidextrous vest
- Shoulder D-rings for accessory attachment
- Two large internal zippered accessory pockets on both front panels (8.5"H x 10"W)
- Four M16/M4 pouches with internal securing straps and dividers hold three magazines each
- Three utility/flashbang pouches and five internal elastic keepers for pens, chem-lights, etc.
- Side light/utility/flashbang pouch and two large daypacks on back for gear, helmets, radio, etc.

PART NUMBER	DESCRIPTION	COLOR	MSRP	MTO
30DV00BK	D.O.A.V. Assault Vest System	Black	\$208.45	MTO



OMEGA® TACTICAL VEST MEDIC/UTILITY

- Adjustable for length and girth (up to 6" length and 32" girth)
- Heavy-duty YKK® zipper and side-release buckles for rapid donning and doffing
- Belt loops secure vest to web belt
- Reinforced drag handle for operator evacuation if injured
- S.T.R.I.K.E.® webbing for attaching pouches or accessories
- Constructed of durable nylon mesh for maximum breathability
- Padded non-slip shoulders for fully ambidextrous vest
- Two large internal zipper accessory pockets on both front panels (8.5"H x 10"W)
- Hook & loop strip for ID patch
- Eight utility pouches for medical supplies and gear

PART NUMBER	DESCRIPTION	COLOR	MSRP	MTO
30EV08BK	Omega™ Tactical Vest Medic/Utility	Black	\$183.95	MTO



TACTICAL FLOAT VEST II

- Adjustable for length and girth (up to 6" length and 32" girth)
- Heavy-duty YKK® zipper and side-release buckles for rapid donning and doffing
- Belt loops secure vest to web belt
- Reinforced drag handle for operator evacuation if injured
- S.T.R.I.K.E.® webbing for attaching pouches or accessories
- Constructed of heavy duty 1000 denier nylon for maximum strength and durability
- U.S. Coast Guard-approved foam
- Non-slip right shoulder for proper stock-weld
- Shoulder D-rings for accessory attachment
- Mag pouches with adjustable flaps for tall or short magazines
- Two Large internal zippered accessory pockets on both front panels (8.5"H x 10"W)
- Two M16/M4 ammo pouches on front hold six magazines total
- Pouches secured with side-release buckles and hook & loop
- Cargo pocket with elastic weave for small items
- Strobe/compass pouch secured by hook & loop flap
- Cargo pocket for medical kit (not included) on right-front panel
- Pouch for Mark 13 day/night flare
- Pocket for several pencil flares and chem-lights
- Small pocket for crotch straps on back secure to front of vest

PART NUMBER	DESCRIPTION	COLOR	MSRP	MTO
30TFV2BK	Tactical Float Vest II	Black	\$208.45	MTO



OMEGA ELITE™ CROSS DRAW/PISTOL MAG VEST

- Adjustable for length and girth (up to 6" length and 32" girth)
- Heavy-duty YKK® zipper and side-release buckles for rapid donning and doffing
- Belt loops secure vest to web belt
- Reinforced drag handle for operator evacuation if injured
- S.T.R.I.K.E.® webbing for attaching pouches or accessories
- Constructed of durable nylon mesh for maximum breathability
- Padded non-slip shoulders for fully ambidextrous vest
- Two large internal zipper accessory pockets on both front panels (8.5"H x 10"W)
- Hook and loop strip for I.D. under
- Cross-draw holster secured by adjustable side-release buckle
- Mag pouches with adjustable flaps for tall or short magazines
- Three M16/M4 pouches hold six magazines total
- Four pistol magazine pouches and one horizontal accessory pouch

PART NUMBER	DESCRIPTION	COLOR	MSRP
30EV26BK	Omega Elite™ Cross Draw/Pistol Mag Vest	Black	\$183.95



OMEGA ELITE™ TACTICAL VEST EOD

- Adjustable for length and girth (up to 6" length and 32" girth)
- Heavy-duty YKK® zipper and side-release buckles for rapid donning and doffing
- Belt loops secure vest to web belt
- Reinforced drag handle for operator evacuation if injured
- S.T.R.I.K.E.® webbing for attaching pouches or accessories
- Constructed of durable nylon mesh for maximum breathability
- Padded non-slip shoulders for fully ambidextrous vest
- Shoulder D-rings for accessory attachment
- Two Large internal zippered accessory pockets on both front panels (8.5"H x 10"W)
- Hook and loop strip for I.D.
- Mag pouches with adjustable flaps for tall or short magazines
- Four horizontal accessory pouches
- Three M16/M4 mag pouches hold six magazines total
- Pistol mag/flashlight pouch
- Includes removable shotshell strip

PART NUMBER	DESCRIPTION	COLOR	MSRP	MTO	NSN
30EV05BK	Omega Elite™ Tactical Vest EOD	Black	\$183.95		
30EV05DE	Omega Elite™ Tactical Vest EOD	Coyote Tan	\$183.95	MTO	8415-01-529-7473



OMEGA ELITE™ OPERATOR VEST - 40MM/RIFLE

- Adjustable for length and girth (up to 6" length and 32" girth)
- Heavy-duty YKK® zipper and side-release buckles for rapid donning and doffing
- Belt loops secure vest to web belt
- Reinforced drag handle for operator evacuation if injured
- S.T.R.I.K.E.® webbing for attaching pouches or accessories
- Constructed of durable nylon mesh for maximum breathability
- Padded non-slip shoulders for fully ambidextrous vest
- Two Large internal zippered accessory pockets on both front panels (8.5"H x 10"W)
- Mag pouches with adjustable flaps for tall or short magazines
- Three M16/M4 pouches hold six magazines total
- One horizontal accessory pouch with hook & loop strip for ID patch
- Eight 40mm pouches

PART NUMBER	DESCRIPTION	COLOR	MSRP	MTO
30EV29CT	Omega Elite™ Operator Vest - 40mm/Rifle	Coyote Tan	\$183.95	MTO
30EV29OD	Omega Elite™ Operator Vest - 40mm/Rifle	Olive Drab	\$183.95	



CUTAWAY OMEGA™ VEST

- Simple cutaway technology with secure release strap and rounded handle under protective nylon band
- Adjustable for length and girth (up to 6" length and 32" girth)
- Heavy-duty YKK® zipper and side-release buckles for rapid donning and doffing
- Belt loops secure vest to web belt
- Reinforced drag handle for operator evacuation if injured
- S.T.R.I.K.E.® webbing for attaching pouches or accessories
- Constructed of durable nylon mesh for maximum breathability
- Padded non-slip shoulders for fully ambidextrous vest
- Two Large internal zippered accessory pockets on both front panels (8.5"H x 10"W)

PART NUMBER	DESCRIPTION	COLOR	MSRP	MTO
30CV01BK	Cutaway Omega™ Vest	Black	\$204.45	MTO



DUTY & PROTECTIVE **POUCHES**



FOUNDATION SERIES BLACK SINGLE 7.62 MAGAZINE POUCH

- Durable, yet flexible 1000D to 500D laminate material
- Lightweight and low profile laser cut MOLLE design
- Elastic side panel construction offers multifit capability
- Top bungee retainer for secure, silent and rapid access

PART NUMBER	DESCRIPTION	COLOR	MSRP
37FS43BK	Foundation Single 7.62 Magazine Pouch	Black	\$24.95



FOUNDATION SERIES BLACK DOUBLE 7.62 MAGAZINE POUCH

- Durable, yet flexible 1000D to 500D laminate material
- Lightweight and low profile laser cut MOLLE design
- Elastic side panel construction offers multifit capability
- Top bungee retainer for secure, silent and rapid access

PART NUMBER	DESCRIPTION	COLOR	MSRP
37FS44BK	Foundation Double 7.62 Magazine Pouch	Black	\$38.95



FOUNDATION SERIES BLACK SINGLE 5.56 MAGAZINE POUCH

- Durable, yet flexible 1000D to 500D laminate material
- Lightweight and low profile laser cut MOLLE design
- Elastic side panel construction offers multifit capability
- Top bungee retainer for secure, silent and rapid access

PART NUMBER	DESCRIPTION	COLOR	MSRP
37FS45BK	Foundation Single 5.56 Magazine Pouch	Black	\$24.95



FOUNDATION SERIES BLACK DOUBLE 5.56 MAGAZINE POUCH

- Durable, yet flexible 1000D to 500D laminate material
- Lightweight and low profile laser cut MOLLE design
- Elastic side panel construction offers multifit capability
- Top bungee retainer for secure, silent and rapid access

PART NUMBER	DESCRIPTION	COLOR	MSRP
37FS46BK	Foundation Double 5.56 Magazine Pouch	Black	\$38.95



FOUNDATION SERIES BLACK SINGLE PISTOL MAGAZINE POUCH

- Durable, yet flexible 1000D to 500D laminate material
- Lightweight and low profile laser cut MOLLE design
- Elastic side panel construction offers multifit capability
- Top bungee retainer for secure, silent and rapid access

PART NUMBER	DESCRIPTION	COLOR	MSRP
37FS47BK	Foundation Single Pistol Magazine Pouch	Black	\$20.95



FOUNDATION SERIES BLACK DOUBLE PISTOL MAGAZINE POUCH

- Durable, yet flexible 1000D to 500D laminate material
- Lightweight and low profile laser cut MOLLE design
- Elastic side panel construction offers multifit capability
- Top bungee retainer for secure, silent and rapid access

PART NUMBER	DESCRIPTION	COLOR	MSRP
37FS48BK	Foundation Double Pistol Magazine Pouch	Black	\$24.95



FOUNDATION SERIES BLACK FLASHBANG POUCH

- Durable, yet flexible 1000D to 500D laminate material
- Lightweight and low profile laser cut MOLLE design
- Elastic side panel construction offers multifit capability
- Quick access flap for added security

PART NUMBER	DESCRIPTION	COLOR	MSRP
37FS49BK	Foundation Flashbang Pouch	Black	\$24.95



FOUNDATION SERIES BLACK RADIO/GPS POUCH

- Durable, yet flexible 1000D to 500D laminate material
- Lightweight and low profile laser cut MOLLE design
- Elastic side panel construction offers multifit capability
- Hook & Loop depth adjustable radio carrier compartment for varied battery sizes
- Top bungee retainer for secure, silent and rapid access

PART NUMBER	DESCRIPTION	COLOR	MSRP
37FS50BK	Foundation Radio/GPS Pouch	Black	\$39.95





FOUNDATION SERIES BLACK IFAK

- Durable, yet flexible 1000D to 500D laminate material
- Lightweight and low profile laser cut MOLLE design
- QASM Surface mount buckle holds contents securely in place
- One hand access ability for quick access
- Pouch opens flat to access its contents

PART NUMBER	DESCRIPTION	COLOR	MSRP
37FS41BK	Foundation IFAK Pouch	Black	\$54.95



FOUNDATION SERIES BLACK TQ W/ GLOVE POUCH

- Durable, yet flexible 1000D to 500D laminate material
- Lightweight and low profile laser cut MOLLE design
- Elastic side panel construction offers multifit capability
- Wrap around hook & loop top flap for TQ retention
- Elastic front glove pouch for rapid access.

PART NUMBER	DESCRIPTION	COLOR	MSRP
37FS42BK	Foundation TQ w/ Glove Pouch	Black	\$24.95



DOUBLE PISTOL MAG POUCH

- Hook and loop attachment for use in gun cases
- Constructed of 500 denier ripstop (solid colors) or CORDURA® nylon (MultiCam®)

PART NUMBER	DESCRIPTION	COLOR	MSRP	NSN
61ACDMBK	Hook Backed Double Pistol Mag Pouch	Black	\$15.45	8465-01-520-5916



TRIPLE M16 MAG POUCH (HOLDS 3)

- Hook and loop attachment for use in gun cases
- Holds three M16 magazines
- Constructed of 500 denier ripstop

PART NUMBER	DESCRIPTION	COLOR	MSRP
65MV01BK	Hook Backed Triple M4/M16 Mag Pouch	Black	\$37.95



FOUNDATION SERIES BLACK UTILITY POUCH

- Durable, yet flexible 1000D to 500D laminate material
- Internal loop wall to attach accessories

PART NUMBER	DESCRIPTION	COLOR	MSRP
37FS40BK	Foundation Utility Pouch	Black	\$35.95



FOUNDATION SERIES FOLDING DUMP POUCH

- Quickly deploy or stow with elastic strap
- Collapsible opening for secure storage of sensitive items

PART NUMBER	DESCRIPTION	COLOR	MSRP
37FS51BK	Foundation Folding Dump Pouch	Black	\$29.95



M16 MAG POUCH (HOLDS 2)

- Hook and loop attachment for use in gun cases
- Constructed of 500 denier nylon
- Holds two 20- or 30-round magazines
- Reinforced bottom with metal grommets for drainage
- Adjustable lid accommodates various length magazines

PART NUMBER	DESCRIPTION	COLOR	MSRP
52HB00CT	Hook Backed Double M4/M16 Mag Pouch	Coyote Tan	\$24.45



M4/M16 SINGLE MAG POUCH (HOLDS 1)

PART NUMBER	DESCRIPTION	COLOR	MSRP
37CL68BK	S.T.R.I.K.E.* Single M4/M16 Mag Pouch	Black	\$20.45
37CL68CT	S.T.R.I.K.E.* Single M4/M16 Mag Pouch	Coyote Tan	\$20.45
37CL68MC	S.T.R.I.K.E.* Single M4/M16 Mag Pouch	MultiCam*	\$22.45
37CL68OD	S.T.R.I.K.E.* Single M4/M16 Mag Pouch	Olive Drab	\$20.45



TIER STACKED M16/M4/P MAG POUCH

PART NUMBER	DESCRIPTION	COLOR	MSRP
37CL118BK	Tier Stacked M4/M16 Mag Pouch	Black	\$25.45
37CL118CT	Tier Stacked M4/M16 Mag Pouch	Coyote Tan	\$25.45
37CL118OD	Tier Stacked M4/M16 Mag Pouch	Olive Drab	\$25.45



TIER STACKED SR25/M14 MAG POUCH

PART NUMBER	DESCRIPTION	COLOR	MSRP
37CL119BK	Tier Stacked M14/FAL Mag Pouch	Black	\$26.45
37CL119MC	Tier Stacked M14/FAL Mag Pouch	MultiCam*	\$28.45
37CL119OD	Tier Stacked M14/FAL Mag Pouch	Olive Drab	\$26.45





SINGLE PISTOL MAG POUCHES

PART NUMBER	DESCRIPTION	COLOR	MSRP
37CL06BK	S.T.R.I.K.E.* Single Pistol Mag	Black	\$13.45
37CL06CT	S.T.R.I.K.E.* Single Pistol Mag	Coyote Tan	\$13.45
37CL06OD	S.T.R.I.K.E.* Single Pistol Mag	Olive Drab	\$13.45



DOUBLE PISTOL MAG POUCH

PART NUMBER	DESCRIPTION	COLOR	MSRP	MTO	NSN
37CL09BK	S.T.R.I.K.E.* Double Pistol Mag	Black	\$21.45		8465-01-560-7829
37CL09MC	S.T.R.I.K.E.* Double Pistol Mag	MultiCam*	\$23.45	MTO	
37CL09OD	S.T.R.I.K.E.* Double Pistol Mag	Olive Drab	\$21.45		8465-01-550-8988



M4/M16 SINGLE MAG POUCH (HOLDS 2)

PART NUMBER	DESCRIPTION	COLOR	MSRP
37CL68BK	S.T.R.I.K.E.* Single M4/M16 Mag Pouch	Black	\$20.45
37CL68CT	S.T.R.I.K.E.* Single M4/M16 Mag Pouch	Coyote Tan	\$20.45
37CL68MC	S.T.R.I.K.E.* Single M4/M16 Mag Pouch	MultiCam*	\$22.45
37CL68OD	S.T.R.I.K.E.* Single M4/M16 Mag Pouch	Olive Drab	\$20.45



M4/M16 DOUBLE MAG POUCH (HOLDS 4)

PART NUMBER	DESCRIPTION	COLOR	MSRP	MTO	NSN
37CL03BK	S.T.R.I.K.E.* M4/M16 Double Mag (Holds 4)	Black	\$39.95		8465-01-560-4128
37CL03CT	S.T.R.I.K.E.* M4/M16 Double Mag (Holds 4)	Coyote Tan	\$39.95		8465-01-554-2837
37CL03MC	S.T.R.I.K.E.* M4/M16 Double Mag (Holds 4)	MultiCam*	\$50.95	MTO	
37CL03OD	S.T.R.I.K.E.* M4/M16 Double Mag (Holds 4)	Olive Drab	\$39.95		



M4/M16 TRIPLE MAG POUCH (HOLDS 6)

PART NUMBER	DESCRIPTION	COLOR	MSRP
37CL04BK	S.T.R.I.K.E.* M4/M16 Triple Mag Pouch (holds 6)	Black	\$37.95



TRIPLE MP-5 MAG POUCH

PART NUMBER	DESCRIPTION	COLOR	MSRP
37CL106BK	Triple MP-5 Magazine Pouch	Black	\$33.95



M4/M16 STAGGERED MAG POUCH (HOLDS 2)

PART NUMBER	DESCRIPTION	COLOR	MSRP	MTO	NSN
37CL65BK	S.T.R.I.K.E.* M4/M16 Staggered Mag Pouch	Black	\$29.45		8465-01-533-3008
37CL65CT	S.T.R.I.K.E.* M4/M16 Staggered Mag Pouch	Coyote Tan	\$29.45		8465-01-533-3007
37CL65MC	S.T.R.I.K.E.* M4/M16 Staggered Mag Pouch	MultiCam*	\$32.95	MTO	
37CL65OD	S.T.R.I.K.E.* M4/M16 Staggered Mag Pouch	Olive Drab	\$29.45	MTO	8465-01-533-3006



AK SINGLE MAGAZINE POUCH

PART NUMBER	DESCRIPTION	COLOR	MSRP
37CL185MC	AK Single Magazine Pouch	MultiCam®	\$36.95
37CL185OD	AK Single Magazine Pouch	Olive Drab	\$33.95



AK47 DOUBLE MAG POUCH (HOLDS 4)

PART NUMBER	DESCRIPTION	COLOR	MSRP
37CL88BK	S.T.R.I.K.E.® AK 47 Double Mag Pouch (Holds 4)	Black	\$49.95
37CL88MC	S.T.R.I.K.E.® AK 47 Double Mag Pouch (Holds 4)	MultiCam®	\$54.45



SINGLE FRAG GRENADE POUCH

PART NUMBER	DESCRIPTION	COLOR	MSRP	NSN
37CL12CT	Single Frag Grenade Pouch	Coyote Tan	\$19.95	8465-01-560-7024
37CL12MC	Single Frag Grenade Pouch	MultiCam®	\$21.95	
37CL12OD	Single Frag Grenade Pouch	Olive Drab	\$19.95	



DOUBLE FRAG GRENADE POUCH

PART NUMBER	DESCRIPTION	COLOR	MSRP	NSN
37CL13BK	Double Frag Grenade Pouch	Black	\$35.95	8465-01-561-3968
37CL13MC	Double Frag Grenade Pouch	MultiCam®	\$40.95	



DOUBLE 40MM GRENADE POUCH

PART NUMBER	DESCRIPTION	COLOR	MSRP
37CL22BK	Double 40mm Grenade Pouch	Black	\$24.95
37CL22MC	Double 40mm Grenade Pouch	MultiCam®	\$27.95



TRIPLE 40MM GRENADE POUCH

PART NUMBER	DESCRIPTION	COLOR	MSRP	NSN
37CL23BK	Triple 40mm Grenade Pouch	Black	\$37.95	8465-01-517-6325
37CL23MC	Triple 40mm Grenade Pouch	MultiCam®	\$38.95	
37CL23OD	Triple 40mm Grenade Pouch	Olive Drab	\$34.95	



SIX ROUND 40MM GRENADE POUCH

PART NUMBER	DESCRIPTION	COLOR	MSRP	NSN
37CL59BK	6 Round 40mm Grenade Pouch	Black	\$34.95	8465-01-581-3802
37CL59CT	6 Round 40mm Grenade Pouch	Coyote Tan	\$34.95	



SMOKE GRENADE SINGLE POUCH

PART NUMBER	DESCRIPTION	COLOR	MSRP	NSN
37CL14BK	S.T.R.I.K.E.* Smoke Grenade Single Pouch	Black	\$20.45	
37CL14OD	S.T.R.I.K.E.* Smoke Grenade Single Pouch	Olive Drab	\$20.45	8465-01-550-3153



FLASHBANG POUCH

PART NUMBER	DESCRIPTION	COLOR	MSRP	NSN
37CL54BK	S.T.R.I.K.E.* Flashbang Pouch	Black	\$19.45	8465-01-560-4130
37CL54CT	S.T.R.I.K.E.* Flashbang Pouch	Coyote Tan	\$19.45	8465-01-555-1505
37CL54MC	S.T.R.I.K.E.* Flashbang Pouch	MultiCam*	\$21.45	
37CL54OD	S.T.R.I.K.E.* Flashbang Pouch	Olive Drab	\$19.45	



18-ROUND SHOT SHELL POUCH

PART NUMBER	DESCRIPTION	COLOR	MSRP
37CL51CT	S.T.R.I.K.E.* 18RND Shotgun Pouch	Coyote Tan	\$33.95
37CL51OD	S.T.R.I.K.E.* 18RND Shotgun Pouch	Olive Drab	\$33.95

UTILITY POUCH

PART NUMBER	DESCRIPTION	COLOR	MSRP	NSN
37CL21BK	S.T.R.I.K.E.* Utility Pouch	Black	\$28.45	8465-01-517-2976
37CL21CT	S.T.R.I.K.E.* Utility Pouch	Coyote Tan	\$28.45	8465-01-554-2842
37CL21MC	S.T.R.I.K.E.* Utility Pouch	MultiCam*	\$31.95	
37CL21OD	S.T.R.I.K.E.* Utility Pouch	Olive Drab	\$28.45	6530-01-518-0915



MEDIUM UTILITY POUCH

PART NUMBER	DESCRIPTION	COLOR	MSRP	NSN
37CL46BK	S.T.R.I.K.E.* Medium Utility Pouch	Black	\$37.95	8465-01-560-4129



PRO MARKSMAN POUCH

- Securely holds 20 rounds of .308 ammunition
- Elastic band protects projectile tips (pen/pencil holder included)
- Side flaps have clear windows so range data can be displayed when opened
- Secured with silent, adjustable side-release buckles

PART NUMBER	DESCRIPTION	COLOR	MSRP	MTO
37CL87BK	S.T.R.I.K.E.* Pro Marksman Pouch	Black	\$39.95	
37CL87CT	S.T.R.I.K.E.* Pro Marksman Pouch	Coyote Tan	\$39.95	
37CL87MC	S.T.R.I.K.E.* Pro Marksman Pouch	MultiCam*	\$42.95	MTO
37CL87OD	S.T.R.I.K.E.* Pro Marksman Pouch	Olive Drab	\$39.95	





LARGE UTILITY POUCH WITH ZIPPER

PART NUMBER	DESCRIPTION	COLOR	MSRP	MTO	NSN
37CL60BK	S.T.R.I.K.E.* Large Utility Pouch w/Zipper	Black	\$38.95		
37CL60CT	S.T.R.I.K.E.* Large Utility Pouch w/Zipper	Coyote Tan	\$38.95		8465-01-553-7869
37CL60MC	S.T.R.I.K.E.* Large Utility Pouch w/Zipper	MultiCam*	\$41.95	MTO	
37CL60OD	S.T.R.I.K.E.* Large Utility Pouch w/Zipper	Olive Drab	\$38.95		



NALGENE® BOTTLE UTILITY POUCH

PART NUMBER	DESCRIPTION	COLOR	MSRP	NSN
37CL70BK	S.T.R.I.K.E.* Utility Pouch w/Nalgene Pocket	Black	\$38.95	8465-01-533-5367



UPRIGHT GP POUCH

PART NUMBER	DESCRIPTION	COLOR	MSRP	MTO
37CL52BK	S.T.R.I.K.E.* Upright GP Pouch	Black	\$37.95	
37CL52MC	S.T.R.I.K.E.* Upright GP Pouch	MultiCam*	\$40.95	MTO
37CL52OD	S.T.R.I.K.E.* Upright GP Pouch	Olive Drab	\$37.95	



PRC-112 POUCH

PART NUMBER	DESCRIPTION	COLOR	MSRP	NSN
37CL26BK	S.T.R.I.K.E.* Radio Pouch-PRC-112	Black	\$32.95	8465-01-517-6328
37CL26CT	S.T.R.I.K.E.* Radio Pouch-PRC-112	Coyote Tan	\$32.95	8465-01-554-2843
37CL26OD	S.T.R.I.K.E.* Radio Pouch-PRC-112	Olive Drab	\$32.95	8465-01-590-0449



RADIO POUCH MBITR

PART NUMBER	DESCRIPTION	COLOR	MSRP	NSN
37CL20BK	S.T.R.I.K.E.* Radio Pouch	Black	\$41.95	
37CL20CT	S.T.R.I.K.E.* Radio Pouch	Coyote Tan	\$41.95	8465-01-555-1507
37CL20MC	S.T.R.I.K.E.* Radio Pouch	MultiCam*	\$43.95	
37CL20OD	S.T.R.I.K.E.* Radio Pouch	Olive Drab	\$41.95	



SMALL RADIO/GPS POUCH

PART NUMBER	DESCRIPTION	COLOR	MSRP	NSN
37CL35BK	S.T.R.I.K.E.* Small Radio/GPS Pouch	Black	\$25.45	8465-01-581-3793
37CL35CT	S.T.R.I.K.E.* Small Radio/GPS Pouch	Coyote Tan	\$25.45	
37CL35MC	S.T.R.I.K.E.* Small Radio/GPS Pouch	MultiCam*	\$27.45	
37CL35OD	S.T.R.I.K.E.* Small Radio/GPS Pouch	Olive Drab	\$25.45	8465-01-581-3790



CUFF/MAG/LIGHT POUCH

PART NUMBER	DESCRIPTION	COLOR	MSRP
37CL55BK	S.T.R.I.K.E.* Cuff/Mag/Light Pouch	Black	\$22.45



GLADIUS/ALLY® PLR FLASHLIGHT POUCH

- A pouch designed specifically for the Blackhawk Gladius and Ally

PART NUMBER	DESCRIPTION	COLOR	MSRP
38CL91BK	Gladius/Ally PLR Flashlight Pouch	Black	\$18.45



ADMIN/FLASHLIGHT POUCH

- Loop panel and S.T.R.I.K.E.* webbing on front for identification and IR markers
- Large main compartment and smaller compartment with elastic loops for securing items
- Flashlight pocket with adjustable lid fits tactical handheld lights
- Grommets for drainage and attaching lanyards/dummy cords
- Dimensions: 7"H x 7.5"W

PART NUMBER	DESCRIPTION	COLOR	MSRP	MTO
37CL114BK	Admin/Flashlight Pouch	Black	\$30.45	
37CL114CT	Admin/Flashlight Pouch	Coyote Tan	\$30.45	
37CL114MC	Admin/Flashlight Pouch	MultiCam*	\$35.95	MTO
37CL114OD	Admin/Flashlight Pouch	Olive Drab	\$30.45	



NIGHT-OPS® FLASHLIGHT HOLDER WITH MOD-U-LOK™ PLATFORM

- Securely carry popular personal tactical lights with 1.25" diameter bezel and 1" diameter body
- Accommodates bezel-up or bezel-down carry
- Quick-disconnect belt loop with one-handed release
- Attach to belt without unthreading other gear
- Fits belts up to 2.25" wide
- Adjustable cant for mounting light at various angles

PART NUMBER	DESCRIPTION	COLOR	MSRP
75GH00BK	Night-Ops® Flashlight Holder	Black	\$24.45



ADMIN/COMPASS/FLASHLIGHT POUCH

PART NUMBER	DESCRIPTION	COLOR	MSRP
37CL32BK	S.T.R.I.K.E.* Admin/Compass/Flashlight Pouch	Black	\$27.45
37CL32OD	S.T.R.I.K.E.* Admin/Compass/Flashlight Pouch	Olive Drab	\$27.45



POP-UP TOURNIQUET POUCH

- Quick access to tourniquet (not included)
- Internal 1.5" strap wraps under tourniquet and through lid for easy tourniquet removal
- Dimensions: 4.75"H x 2.25"W x 2.25"D

PART NUMBER	DESCRIPTION	COLOR	MSRP
37CL107BK	Pop-up Tourniquet Pouch	Black	\$21.45
37CL107CT	Pop-up Tourniquet Pouch	Coyote Tan	\$21.45
37CL107OD	Pop-up Tourniquet Pouch	Olive Drab	\$21.45



COMPACT MEDICAL POUCH

- Removable internal panel with multiple loops to organize and retain medical supplies
- Encased foam handle for quick one-handed operation
- Red zipper pulls for medical content identification
- Grommets for drainage
- 2.5" x 2.5" loop panel for patch attachment
- Can be configured for belt wear
- Dimensions: 6.75"H x 4.25"W x 2"D

PART NUMBER	DESCRIPTION	COLOR	MSRP	MTO
37CL124BK	Compact Medical Pouch	Black	\$35.95	
37CL124CT	Compact Medical Pouch	Coyote Tan	\$35.95	
37CL124OD	Compact Medical Pouch	Olive Drab	\$35.95	MTO



QUICK RELEASE MED POUCH

- Removable medical pouch disconnects quickly from platform
- Side-release buckle for additional security
- Red handle and zipper pulls for medical content identification
- Grommets for drainage
- Internal pocket and elastic straps for stowing critical supplies
- 2.5" x 2.5" loop on front for patch attachment
- Can be configured for belt wear
- Dimensions: 7"H x 5.5"W x 3"D

PART NUMBER	DESCRIPTION	COLOR	MSRP	MTO
37CL116BK	Quick Release Medical Pouch	Black	\$40.95	
37CL116CT	Quick Release Medical Pouch	Coyote Tan	\$40.95	
37CL116MC	Quick Release Medical Pouch	MultiCam*	\$46.95	MTO
37CL116OD	Quick Release Medical Pouch	Olive Drab	\$40.95	



MEDICAL POUCH

PART NUMBER	DESCRIPTION	COLOR	MSRP	NSN
37CL18BK	S.T.R.I.K.E.* Medical Pouch	Black	\$35.95	8465-01-562-4845
37CL18CT	S.T.R.I.K.E.* Medical Pouch	Coyote Tan	\$35.95	8465-01-561-3969
37CL18MC	S.T.R.I.K.E.* Medical Pouch	MultiCam*	\$38.95	
37CL18OD	S.T.R.I.K.E.* Medical Pouch	Olive Drab	\$35.95	6530-01-518-0508





VEHICLE QD MEDICAL POUCH

- Mounts to most automobile headrests and some visors
- Quick detach feature allows instant removal from stowed position
- Red zipper pulls and grab handle identify the contents as medical supplies
- Loop panel on front of pouch allows attachment of additional hook back ID patches
- Made of high-quality materials such as 500 denier nylon and YKK® zippers

PART NUMBER	DESCRIPTION	COLOR	MSRP	MTO
20VP00BK	Vehicle QD Medical Pouch	Black	\$41.95	MTO



SIDE HYDRATION POUCH

- Mount on side, back, front or backpack using Speed Clips™
- Drink system protected by Microban® antimicrobial technology
- Bite valve and patent-pending quick-disconnect system
- Capacity is 40 oz./1 L
- Dimensions: 10"H x 7"W x 1.5"D

PART NUMBER	DESCRIPTION	COLOR	MSRP
65SH00BK	Side Hydration Pch w/ Speed Clips	Black	\$66.45
65SH00CT	Side Hydration Pch w/ Speed Clips	Coyote Tan	\$66.45



S.T.R.I.K.E.® ROLL-UP DUMP POUCH

- Internal elastic loops for light sticks, shotgun shells, etc.
- Shock cord cinches tight to retain contents
- Stiffener in opening of main compartment holds pouch open for easy access
- Grommets for drainage
- S.T.R.I.K.E.® webbing on front for attaching additional items
- Dimensions: 10"H x 8.5"W x 3.75"D

PART NUMBER	DESCRIPTION	COLOR	MSRP	MTO
37CL117BK	Roll-up MOLLE Dump Pouch	Black	\$40.95	
37CL117CT	Roll-up MOLLE Dump Pouch	Coyote Tan	\$40.95	
37CL117MC	Roll-up MOLLE Dump Pouch	MultiCam®	\$45.95	MTO
37CL117OD	Roll-up MOLLE Dump Pouch	Olive Drab	\$40.95	



SPEED CLIPS™

- Quickly and efficiently mount and disconnect pouches and other modular gear to any S.T.R.I.K.E.® or PALS/MOLLE platform.
- Eliminate tedious weaving and tested in combat
- Constructed of durable yet flexible polymer
- Designed to mount Speed Clip™ 3800 Series pouches to any S.T.R.I.K.E.® or PALS/MOLLE platform
- Multiple lengths span various widths of webbing to accommodate any size pouch
- # indicates how many widths are spanned
- Patent pending

PART NUMBER	DESCRIPTION	COLOR	MSRP
38C906CT	Speed Clips, six #9s	Coyote Tan	\$24.45
38C906BK	Speed Clips, six #9s	Black	\$24.45
38C706OD	Speed Clips, six #7s	Olive Drab	\$14.95
38C706CT	Speed Clips, six #7s	Coyote Tan	\$14.95
38C706BK	Speed Clips, six #7s	Black	\$14.95
38C506OD	Speed Clips, six #5s	Olive Drab	\$14.95
38C506CT	Speed Clips, six #5s	Coyote Tan	\$14.95
38C506BK	Speed Clips, six #5s	Black	\$14.95
38C306OD	Speed Clips, six #3s	Olive Drab	\$9.95
38C306FG	Speed Clips, six #3s	Foliage Green	\$9.95
38C306CT	Speed Clips, six #3s	Coyote Tan	\$9.95
38C306BK	Speed Clips, six #3s	Black	\$9.95

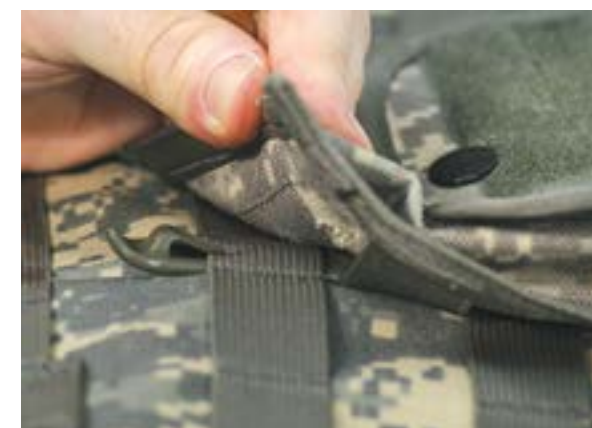

FOLDING DUMP POUCH

- Hook & loop closure
- Belt-mounted folding/roll-up dump pouch
- Low-profile design for use as magazine dump pouch, evidence bag, flex cuff pouch, etc.
- Dimensions: 11"H x 8"W x 5"D

PART NUMBER	DESCRIPTION	COLOR	MSRP
37CL77CT	Folding Dump Pouch	Coyote Tan	\$25.45



DUTY & PROTECTIVE BELTS



FOUNDATION GUN BELT

- Durable, yet flexible 1000D to 500D laminate material
- Lightweight and low profile laser cut MOLLE design
- Double layer Scuba webbing offers rigid mounting base
- Inner surface lined with hook and affixes to inner belt
- Side-Lock buckle

PART NUMBER	DESCRIPTION	COLOR	SIZE	MSRP	MTO
37FS20BK	Foundation Gun Belt	Black	SM (29"-34")	\$49.95	
37FS21BK	Foundation Gun Belt	Black	MD (34"-39")	\$49.95	
37FS22BK	Foundation Gun Belt	Black	LG (39"-44")	\$49.95	
37FS23BK	Foundation Gun Belt	Black	XL (44"-49")	\$49.95	
WITH COBRA BUCKLE					
37FS24BK	Foundation Gun Belt with Cobra Buckle	Black	SM (29"-34")	\$TBD	MTO
37FS25BK	Foundation Gun Belt with Cobra Buckle	Black	MD (34"-39")	\$TBD	MTO
37FS26BK	Foundation Gun Belt with Cobra Buckle	Black	LG (39"-44")	\$TBD	MTO
37FS27BK	Foundation Gun Belt with Cobra Buckle	Black	XL (44"-49")	\$TBD	MTO



FOUNDATION INNER BELT

- Exterior loop affixes to Foundation Gunbelt for stability.

PART NUMBER	DESCRIPTION	COLOR	SIZE	MSRP
37FS28BK	Foundation Inner Belt	Black	SM/MD	\$20.95
37FS29BK	Foundation Inner Belt	Black	MD/LG	\$20.95





CQB/RIGGER'S BELT

- Parachute-grade buckles and adapters meet PIA-H-7195 standards
- 1.75" webbing with 7,000-lb. tensile strength (solid colors) or 5,000-lb. tensile strength (MultiCam®)
- Hook & loop secures running end

PART NUMBER	DESCRIPTION	COLOR	SIZE	MSRP	MTO	NSN
41CQ00499	CQB/Rigger's Belt	Coyote 499	SM (Up to 34")	\$86.95	MTO	
41CQ00BK	CQB/Rigger's Belt	Black	SM (Up to 34")	\$46.95		4240-01-519-2622
41CQ00DE	CQB/Rigger's Belt	Coyote Tan	SM (Up to 34")	\$46.95		4240-01-586-2392
41CQ00MC	CQB/Rigger's Belt	MultiCam®	SM (Up to 34")	\$59.95		
41CQ00OD	CQB/Rigger's Belt	Olive Drab	SM (Up to 34")	\$46.95		4240-01-596-2112
41CQ01499	CQB/Rigger's Belt	Coyote 499	MD (Up To 41")	\$86.95	MTO	
41CQ01BK	CQB/Rigger's Belt	Black	MD (Up To 41")	\$46.95		4240-01-509-6087
41CQ01DE	CQB/Rigger's Belt	Coyote Tan	MD (Up To 41")	\$46.95		4240-01-529-7437
41CQ01MC	CQB/Rigger's Belt	MultiCam®	MD (Up To 41")	\$59.95		
41CQ01OD	CQB/Rigger's Belt	Olive Drab	MD (Up To 41")	\$46.95		4240-01-596-2113
41CQ02499	CQB/Rigger's Belt	Coyote 499	LG(41"-51")	\$86.95	MTO	
41CQ02BK	CQB/Rigger's Belt	Black	LG(41"-51")	\$46.95		4240-01-509-6086
41CQ02DE	CQB/Rigger's Belt	Coyote Tan	LG(41"-51")	\$46.95		4240-01-560-6022
41CQ02MC	CQB/Rigger's Belt	MultiCam®	LG(41"-51")	\$59.95		
41CQ02OD	CQB/Rigger's Belt	Olive Drab	LG(41"-51")	\$46.95		4240-01-519-2779



CQB/RIGGER'S BELT WITH COBRA BUCKLE

- Parachute-grade buckles and adapters meet PIA-H-7195 standards
- 1.75" webbing with 7,000-lb. tensile strength (solid colors) or 5,000-lb. tensile strength (MultiCam®)
- Hook & loop secures running end

PART NUMBER	DESCRIPTION	COLOR	SIZE	MSRP
41CQ11BK	Rigger's Belt w/ Cobra Buckle	Black	SM (Up to 34")	\$89.95
41CQ11DB	Rigger's Belt w/ Cobra Buckle	Desert Sand	SM (Up to 34")	\$89.95
41CQ11DE	Rigger's Belt w/ Cobra Buckle	Coyote Tan	SM (Up to 34")	\$89.95
41CQ11MC	Rigger's Belt w/ Cobra Buckle	MultiCam®	SM (Up to 34")	\$89.95
41CQ11OD	Rigger's Belt w/ Cobra Buckle	Olive Drab	SM (Up to 34")	\$89.95
41CQ12BK	Rigger's Belt w/ Cobra Buckle	Black	MD (Up To 41")	\$89.95
41CQ12DB	Rigger's Belt w/ Cobra Buckle	Desert Sand	MD (Up To 41")	\$89.95
41CQ12DE	Rigger's Belt w/ Cobra Buckle	Coyote Tan	MD (Up To 41")	\$89.95
41CQ12MC	Rigger's Belt w/ Cobra Buckle	MultiCam®	MD (Up To 41")	\$89.95
41CQ12OD	Rigger's Belt w/ Cobra Buckle	Olive Drab	MD (Up To 41")	\$89.95
41CQ13BK	Rigger's Belt w/ Cobra Buckle	Black	LG(41"-51")	\$89.95
41CQ13DB	Rigger's Belt w/ Cobra Buckle	Desert Sand	LG(41"-51")	\$89.95
41CQ13DE	Rigger's Belt w/ Cobra Buckle	Coyote Tan	LG(41"-51")	\$89.95
41CQ13MC	Rigger's Belt w/ Cobra Buckle	MultiCam®	LG(41"-51")	\$89.95
41CQ13OD	Rigger's Belt w/ Cobra Buckle	Olive Drab	LG(41"-51")	\$89.95



INSTRUCTOR'S GUN BELT - 1.5"

- Polyethylene spine to help bear the weight of belt-mounted holsters and equipment
- Parachute-grade buckles and adapters meet PIA-H-7195 standards
- 1.5" webbing with 7,000-lb. tensile strength (solid colors) or 4,000-lb. tensile strength (MultiCam®)
- Hook & loop secures running end

PART NUMBER	DESCRIPTION	COLOR	SIZE	MSRP
41VT10BK	1.5" Instructors Gun Belt	Black	SM (Up to 34")	\$50.95
41VT10MC	1.5" Instructors Gun Belt	MultiCam®	SM (Up to 34")	\$61.95
41VT11BK	1.5" Instructors Gun Belt	Black	MD (31"-41")	\$54.95
41VT12BK	1.5" Instructors Gun Belt	Black	LG (41" - 51")	\$54.95



INSTRUCTOR'S GUN BELT - 1.75"

- Polyethylene spine to help bear the weight of belt-mounted holsters and equipment
- Parachute-grade buckles and adapters meet PIA-H-7195 Standards
- 1.75" webbing with 7,000-lb. tensile strength
- Hook & loop secures running end

PART NUMBER	DESCRIPTION	COLOR	SIZE	MSRP
41VT01BK	1.75" Instructors Gun Belt	Black	MD (34" - 41")	\$54.95
41VT02BK	1.75" Instructors Gun Belt	Black	LG (41" - 51")	\$54.95



INSTRUCTOR'S BELT W/COBRA BUCKLE

- Rated COBRA quick-detach buckle 1.75in 7,000lb tensile strength webbing
- Polymer reinforced construction
- Loop lined
- Buckle meets PIA-H-7195 standards
- Hook & loop secures running end

PART NUMBER	DESCRIPTION	COLOR	SIZE	MSRP
41VT40BK	Instructor's Belt w/Cobra Buckle	Black	SM (Up to 34")	\$79.95
41VT41BK	Instructor's Belt w/Cobra Buckle	Black	MD (31"-41")	\$79.95
41VT42BK	Instructor's Belt w/Cobra Buckle	Black	LG (41" - 51")	\$79.95



2" & 2.25" WEB DUTY BELTS

- Double-layer nylon web design
- Triple-retention buckle and molded keepers for tough use

PART NUMBER	DESCRIPTION	COLOR	SIZE	MSRP
44B6LGBK	2" Web Duty Belt	Black	LG	\$24.95
44B6MDBK	2" Web Duty Belt	Black	MD	\$24.95
44B6SMBK	2" Web Duty Belt	Black	SM	\$24.95
44B6XLBK	2" Web Duty Belt	Black	XL	\$24.95
44B10XSbk	2.25" Web Duty Belt	Black	XS	\$26.95
44B10XLBK	2.25" Web Duty Belt	Black	XL	\$26.95
44B10SMBK	2.25" Web Duty Belt	Black	SM	\$26.95
44B10MDBK	2.25" Web Duty Belt	Black	MD	\$26.95
44B10LGBK	2.25" Web Duty Belt	Black	LG	\$26.95
44B102XLBK	2.25" Web Duty Belt	Black	XL	\$26.95



REINFORCED 2" & 2.25" DUTY BELT WITH LOOP INNER

- Nylon loop inner surface mates up to nylon hook in Blackhawk® inner duty belts

PART NUMBER	DESCRIPTION	COLOR	FINISH	SIZE	MSRP
44B4LGBK	Reinforced 2" Duty Belt w/Loop Inner	Black	Webbing	LG	\$30.95
44B4LGBW	Reinforced 2" Duty Belt w/Loop Inner	Black	Basketweave	LG	\$52.95
44B4LGPL	Reinforced 2" Duty Belt w/Loop Inner	Black	Plain	LG	\$52.95
44B4MDBK	Reinforced 2" Duty Belt w/Loop Inner	Black	Webbing	MD	\$30.95
44B4MDBW	Reinforced 2" Duty Belt w/Loop Inner	Black	Basketweave	MD	\$52.95
44B4MDPL	Reinforced 2" Duty Belt w/Loop Inner	Black	Plain	MD	\$52.95
44B4SMBK	Reinforced 2" Duty Belt w/Loop Inner	Black	Webbing	SM	\$30.95
44B4SMBW	Reinforced 2" Duty Belt w/Loop Inner	Black	Basketweave	SM	\$52.95
44B4SMPL	Reinforced 2" Duty Belt w/Loop Inner	Black	Plain	SM	\$52.95
44B4XLBK	Reinforced 2" Duty Belt w/Loop Inner	Black	Webbing	XL	\$30.95
44B4XLBW	Reinforced 2" Duty Belt w/Loop Inner	Black	Basketweave	XL	\$52.95
44B4XLPL	Reinforced 2" Duty Belt w/Loop Inner	Black	Plain	XL	\$52.95
44B4XXBK	Reinforced 2" Duty Belt w/Loop Inner	Black	Webbing	2XL	\$52.95
44B4XXBW	Reinforced 2" Duty Belt w/Loop Inner	Black	Basketweave	2XL	\$55.95
44B4XXPL	Reinforced 2" Duty Belt w/Loop Inner	Black	Plain	2XL	\$55.95
44B122XLBK	Reinforced 2.25" Duty Belt w/Loop Inner	Black	Webbing	XL	\$41.95
44B122XLBW	Reinforced 2.25" Duty Belt w/Loop Inner	Black	Basketweave	XL	\$62.95
44B122XLPL	Reinforced 2.25" Duty Belt w/Loop Inner	Black	Plain	XL	\$62.95
44B12LGBK	Reinforced 2.25" Duty Belt w/Loop Inner	Black	Webbing	LG	\$36.95
44B12LGBW	Reinforced 2.25" Duty Belt w/Loop Inner	Black	Basketweave	LG	\$54.95
44B12LGPL	Reinforced 2.25" Duty Belt w/Loop Inner	Black	Plain	LG	\$54.95
44B12MDBK	Reinforced 2.25" Duty Belt w/Loop Inner	Black	Webbing	MD	\$36.95
44B12MDBW	Reinforced 2.25" Duty Belt w/Loop Inner	Black	Basketweave	MD	\$54.95
44B12MDPL	Reinforced 2.25" Duty Belt w/Loop Inner	Black	Plain	MD	\$54.95
44B12SMBK	Reinforced 2.25" Duty Belt w/Loop Inner	Black	Webbing	SM	\$36.95
44B12SMBW	Reinforced 2.25" Duty Belt w/Loop Inner	Black	Basketweave	SM	\$54.95
44B12SMPL	Reinforced 2.25" Duty Belt w/Loop Inner	Black	Plain	SM	\$54.95
44B12XLBK	Reinforced 2.25" Duty Belt w/Loop Inner	Black	Webbing	XL	\$36.95
44B12XLBW	Reinforced 2.25" Duty Belt w/Loop Inner	Black	Basketweave	XL	\$54.95
44B12XLPL	Reinforced 2.25" Duty Belt w/Loop Inner	Black	Plain	XL	\$54.95
44B12XSBK	Reinforced 2.25" Duty Belt w/Loop Inner	Black	Webbing	XS	\$36.95
44B12XSBW	Reinforced 2.25" Duty Belt w/Loop Inner	Black	Basketweave	XS	\$54.95
44B12XSPL	Reinforced 2.25" Duty Belt w/Loop Inner	Black	Plain	XS	\$54.95



ERGONOMIC DUTY BELT HARNESS

- Broad fit range and no moving parts to fail
- NIJ selected and funded to address back and hip pain
- Helps alleviate discomfort caused by heavy-duty belts
- Eliminates issues associated with external suspender systems
- Can be worn under duty shirt with slight modifications
- Compatible with most concealment armor packages
- Accommodates duty belts up to 2.25" wide

PART NUMBER	DESCRIPTION	COLOR	SIZE	MSRP
44H002BK	Ergonomic Duty Belt Harness	Black	LG/XL /2XL	\$81.95
44H001BK	Ergonomic Duty Belt Harness	Black	SM/MD	\$81.95



REINFORCED 2" & 2.25" WEB DUTY BELT

- Double-layer nylon web design with polymer spine reinforcement
- Nylon binding for smooth edge, comfort and professional appearance
- Triple-retention buckle and molded keepers for tough use

PART NUMBER	DESCRIPTION	COLOR	SIZE	MSRP
44B3XLBK	Reinforced 2" Web Duty Belt	Black	XL	\$29.95
44B3SMBK	Reinforced 2" Web Duty Belt	Black	SM	\$29.95
44B3MDBK	Reinforced 2" Web Duty Belt	Black	MD	\$29.95
44B3LGBK	Reinforced 2" Web Duty Belt	Black	LG	\$29.95
44B11XSBK	Reinforced 2.25" Web Duty Belt	Black	XS	\$34.95
44B11LGBK	Reinforced 2.25" Web Duty Belt	Black	XL	\$34.95
44B11SMBK	Reinforced 2.25" Web Duty Belt	Black	SM	\$34.95
44B11MDBK	Reinforced 2.25" Web Duty Belt	Black	MD	\$34.95
44B11LGBK	Reinforced 2.25" Web Duty Belt	Black	LG	\$34.95
44B112XLBK	Reinforced 2.25" Web Duty Belt	Black	2XL	\$41.95



2.25" ERGONOMIC PADDED DUTY BELT

- Constructed of molded CORDURA®
- Ergonomically designed with padded edges
- Triple-retention buckle
- Nylon loop backing mates up to Inner Trouser Belt (sold separately)

PART NUMBER	DESCRIPTION	COLOR	SIZE	MSRP
44B2LGBK	2.25" Ergonomic Padded Duty Belt	Black	LG	\$40.95
44B2MDBK	2.25" Ergonomic Padded Duty Belt	Black	MD	\$40.95
44B2SMBK	2.25" Ergonomic Padded Duty Belt	Black	SM	\$40.95
44B2XLBK	2.25" Ergonomic Padded Duty Belt	Black	XL	\$45.95
44B2XXBK	2.25" Ergonomic Padded Duty Belt	Black	2XL	\$45.95



LOOPBACK INNER DUTY BELT

- Comfortable, easy-to-use design
- Low-profile, nylon loopback buckle for easy size adjustment

PART NUMBER	DESCRIPTION	COLOR	SIZE	MSRP
44B5LGBK	1.5" Loopback Inner Duty Belt	Black	LG	\$16.95
44B5MDBK	1.5" Loopback Inner Duty Belt	Black	MD	\$16.95
44B5SMBK	1.5" Loopback Inner Duty Belt	Black	SM	\$16.95
44B5XLBK	1.5" Loopback Inner Duty Belt	Black	XL	\$16.95



HOOK & LOOP INNER DUTY BELT

- Nylon hook & loop closure

PART NUMBER	DESCRIPTION	COLOR	SIZE	MSRP
44B7XLBK	Hook & Loop Inner Duty Belt	Black	XL	\$13.95
44B7SMBK	Hook & Loop Inner Duty Belt	Black	SM	\$13.95
44B7MDBK	Hook & Loop Inner Duty Belt	Black	MD	\$13.95
44B7LGBK	Hook & Loop Inner Duty Belt	Black	LG	\$13.95



MILITARY WEB BELT (MODERNIZED)

- 2.25" wide belt with three point side-release buckle for quick-on/quick-off (no heavy metal hardware)
- Hook & loop size adjustment
- Top choice among the military

PART NUMBER	DESCRIPTION	COLOR	SIZE	MSRP	MTO	NSN
41WB02BK	Military Web Belt-Modernized	Black	LG (Up to 43")	\$34.95		
41WB02DE	Military Web Belt-Modernized	Coyote Tan	LG (Up to 43")	\$34.95		
41WB02FG	Military Web Belt-Modernized	Foliage Green	LG (Up to 43")	\$30.95	MTO	
41WB02OD	Military Web Belt-Modernized	Olive Drab	LG (Up to 43")	\$34.95		
41WB03BK	Military Web Belt-Modernized	Black	XL (44"-49")	\$34.95		8465-01-545-5740
41WB03DE	Military Web Belt-Modernized	Coyote Tan	XL (44"-49")	\$34.95		
41WB03FG	Military Web Belt-Modernized	Foliage Green	XL (44"-49")	\$31.95	MTO	
41WB03OD	Military Web Belt-Modernized	Olive Drab	XL (44"-49")	\$34.95		8465-01-545-5741



INNER TROUSER BELT

- Molded nylon hook won't fray belt loops or trousers
- Woven nylon hook mates up to nylon loop on inside of duty
- Reversible for courtroom wear

PART NUMBER	DESCRIPTION	COLOR	SIZE	MSRP
44B1XXBK	1.5" Inner Trouser Belt	Black	2XL	\$23.95
44B1XSBK	1.5" Inner Trouser Belt	Black	XS	\$23.95
44B1XLBK	1.5" Inner Trouser Belt	Black	XL	\$23.95
44B1SMBK	1.5" Inner Trouser Belt	Black	SM	\$23.95
44B1MDBK	1.5" Inner Trouser Belt	Black	MD	\$23.95
44B1LGBK	1.5" Inner Trouser Belt	Black	LG	\$23.95



HANDGUN



SHOTGUN



RIFLE

CARTRIDGE BELT

- Durable cam buckle and nylon construction
- Universal cartridge belts fit up to 50" waist

PART NUMBER	DESCRIPTION	COLOR	SIZE	MSRP	MTO
74BC02BK	Shotgun Cartridge Belt	Black	Up to 50"	\$21.95	MTO





UNIVERSAL BDU BELT

- Lightweight 1.75" wide belt with metal friction buckle
- One size fits all (up to 52")

PART NUMBER	DESCRIPTION	COLOR	SIZE	MSRP
41UB01BK	Universal BDU Belt	Black	One Size - Up to 52"	\$16.95
41UB01DB	Universal BDU Belt	Desert Sand Brown	One Size - Up to 52"	\$16.95
41UB01DE	Universal BDU Belt	Coyote Tan	One Size - Up to 52"	\$16.95



PADED PATROL BELT

- Closed-cell foam will not absorb moisture or perspiration
- S.T.R.I.K.E.® webbing for attaching pouches or accessories
- Secured by 2.25" three point side release buckle and hook / loop tabs

PART NUMBER	DESCRIPTION	COLOR	SIZE	MSRP	NSN
41PBT1DE	Padded Patrol Belt w/ IVS™	Coyote Tan	SM (37"-43")	\$44.95	8465-01-562-3120
41PBT2DE	Padded Patrol Belt w/ IVS™	Coyote Tan	MD (43"-49")	\$42.95	8465-01-585-9124
41PBT3DE	Padded Patrol Belt w/ IVS™	Coyote Tan	LG (46"-52")	\$44.95	8465-01-562-3119



BELT PAD WITH IVS™

- Constructed of 1000 denier nylon
- .375" closed-cell foam padding will not absorb moisture or perspiration
- Belt keepers fit belts up to a 2.25" wide

PART NUMBER	DESCRIPTION	COLOR	SIZE	MSRP	MTO
41BP00BK	Belt Pad w/IVS™	Black	SM (28"-34")	\$34.95	
41BP00OD	Belt Pad w/IVS™	Olive Drab	SM (28"-34")	\$24.95	MTO
41BP02BK	Belt Pad w/IVS™	Black	MD (36"-40")	\$34.95	
41BP02OD	Belt Pad w/IVS™	Olive Drab	MD (36"-40")	\$25.95	MTO
41BP03BK	Belt Pad w/IVS™	Black	LG (42"-48")	\$34.95	
41BP03OD	Belt Pad w/IVS™	Olive Drab	LG (42"-48")	\$28.95	MTO



ENHANCED PATROL BELT PAD

- Closed-cell foam padding will not absorb moisture
- 3-D mesh for comfort and ventilation
- Fits belts up to 2.75" wide
- Two rows of S.T.R.I.K.E.® webbing for attaching pouches or accessories
- Convenient openings help guide belt through pad
- Non-slip lining keeps pad in place
- Accommodates Military Web Belt (sold separately)

PART NUMBER	DESCRIPTION	COLOR	SIZE	MSRP
41PB01CT	Enhanced Patrol Belt Pad	Coyote Tan	MD (36"-40")	\$44.95



BORN FROM EXPERIENCE. MADE FOR THE MISSION.



DUTY & PROTECTIVE **DUTY GEAR**



MOLDED CORDURA® DUTY GEAR



PLAIN FINISH MOLDED DUTY GEAR



BASKETWEAVE MOLDED DUTY GEAR



**TRADITIONAL-STYLE NYLON
DUTY GEAR COMBO KIT**

NEW PRODUCTS

HOLSTERS

DUTY & PROTECTIVE

APPAREL

BAGS & PACKS

ACCESSORIES



MOLDED CORDURA® DUTY GEAR

- Traditional-looking yet street-tough duty gear
- Proprietary five-layer laminate system with an integral polymer core for long-lasting service life
- Combines the lightweight, high-performance, disinfecting properties of nylon with a classic molded look
- Basketweave and Plain Finish Molded Duty Gear feature a traditional leather appearance
- Molded CORDURA® Duty Gear ads the benefits of tough, abrasion-resistant CORDURA® nylon

PART NUMBER	DESCRIPTION	MSRP	NSN
44A000BK	Double Mag Pouch-Single Stack	\$44.95	
44A001BK	Double Mag Pouch-Double Stack	\$36.95	
44A002BK	Double Mag Pouch-Double Stack (Glock 21)	\$36.95	
44A003BK	Single Mag Pouch-Double Stack	\$26.95	
44A100BK	Handcuff Pouch Single	\$30.95	
44A101BK	Double Handcuff Case	\$33.95	
44A200BK	Light Pouch 6P/6R/TL-2*/TT-2/M-6	\$23.95	
44A201BK	Light/Baton Holder (D-Cell/C-Cell)	\$10.95	
44A203BK	Stinger™ Light Pouch	\$32.95	
44A300BK	Latex Glove Pouch	\$22.45	
44A400BK	Radio Pouch	\$40.95	
44A500BK	Chem Agent Medium (MK3)	\$24.95	8105-01-592-1260
44A501BK	Chem Agent Large (MK4)	\$26.95	
44A502BK	Chem Agent Punch II Canister Pouch	\$33.95	
44A600BK	Silent Key Holder	\$20.95	
44A700BK	Expandable Baton Carrier	\$21.95	
44A800BK	TASER® Cartridge Holder	\$25.95	
44B300BK	Molded Belt Keepers (Set of 4)	\$19.95	



PLAIN FINISH MOLDED DUTY GEAR

- Traditional-looking yet street-tough duty gear
- Proprietary five-layer laminate system with an integral polymer core for long-lasting service life
- Combines the lightweight, high-performance, disinfecting properties of nylon with a classic molded look
- Basketweave and Plain Finish Molded Duty Gear feature a traditional leather appearance
- Molded CORDURA® Duty Gear adds the benefits of tough, abrasion-resistant CORDURA® nylon

PART NUMBER	DESCRIPTION	COLOR	MSRP
44A001PL	Double Mag Pouch-Double Stack	Black	\$44.95
44A002PL	Double Mag Pouch-Double Stack (Glock 21)	Black	\$44.95
44A100PL	Handcuff Pouch Single	Black	\$33.95
44A101PL	Double Handcuff Case	Black	\$40.95
44A300PL	Latex Glove Pouch	Black	\$26.95
44A400PL	Radio Pouch	Black	\$47.95
44A500PL	Chem Agent Medium (MK3)	Black	\$30.95
44A600PL	Silent Key Holder	Black	\$25.95
44A700PL	Expandable Baton Carrier	Black	\$26.95



BASKETWEAVE MOLDED DUTY GEAR

- Traditional-looking yet street-tough duty gear
- Proprietary five-layer laminate system with an integral polymer core for long-lasting service life
- Combines the lightweight, high-performance, disinfecting properties of nylon with a classic molded look
- Basketweave and Plain Finish Molded Duty Gear feature a traditional leather appearance
- Molded CORDURA® Duty Gear adds the benefits of tough, abrasion-resistant CORDURA® nylon

PART NUMBER	DESCRIPTION	COLOR	MSRP
44A000BW	Double Mag Pouch-Single Stack	Black	\$44.95
44A001BW	Double Mag Pouch-Double Stack	Black	\$44.95
44A002BW	Double Mag Pouch-Double Stack (Glock 21)	Black	\$44.95
44A100BW	Handcuff Pouch Single	Black	\$35.45
44A101BW	Double Handcuff Case	Black	\$42.45
44A203BW	Stinger™ Light Pouch	Black	\$35.95
44A300BW	Latex Glove Pouch	Black	\$26.95
44A400BW	Radio Pouch	Black	\$47.95
44A500BW	Chem Agent Medium (MK3)	Black	\$30.95
44A600BW	Silent Key Holder	Black	\$26.95
44A700BW	Expandable Baton Carrier	Black	\$26.95
44B300BW	Molded Belt Keepers (Set of 4)	Black	\$19.95



TRADITIONAL-STYLE NYLON DUTY GEAR COMBO KIT

- Constructed of durable, easy-care CORDURA® nylon with waterproof closed-cell foam padding
- Flexible polymer reinforcement and 150 denier knit lining to give years of service
- Kit includes one 2" Web Duty Belt (44B6), one Expandable Baton Case (44A750BK), One Set of Four (4) Nylon Belt Keepers (44B351BK), one Chemical Agent Case (44A551BK), One Silent Key Holder (44A650BK), one Universal Radio Case (44A450BK), one Single Cuff Case (44A153BK), one Stinger™ Light Case (44A251BK), one Latex Glove Case (44A351BK)

PART NUMBER	DESCRIPTION	SIZE	MSRP
44AK10BK-LG	Traditional-Style Nylon Duty Gear Combo Kit	LG	\$172.45
44AK10BK-MD	Traditional-Style Nylon Duty Gear Combo Kit	MD	\$172.45
44AK10BK-SM	Traditional-Style Nylon Duty Gear Combo Kit	SM	\$172.45
44AK10BK-XL	Traditional-Style Nylon Duty Gear Combo Kit	XL	\$172.45

TRADITIONAL-STYLE NYLON DUTY GEAR

- Traditional-looking yet street-tough duty gear
- Proprietary five-layer laminate system with an integral polymer core for long-lasting service life
- Combines the lightweight, high-performance, disinfecting properties of nylon with a classic molded look
- Basketweave and Plain Finish Molded Duty Gear feature a traditional leather appearance
- Molded CORDURA® Duty Gear adds the benefits of tough, abrasion-resistant CORDURA® nylon

PART NUMBER	DESCRIPTION	SIZE	MSRP
44A050BK	Single Magazine Case-Single Stack		\$22.45
44A051BK	Single Mag Pouch-Double Stack		\$22.45
44A054BK	Universal Double Mag Case		\$28.95
44A055BK	Universal Single Mag/Knife Case- Single Stack Mags		\$17.95
44A056BK	Divided Pistol Mag Case with Inserts-Single Stack Mags		\$44.95
44A057BK	Divided Dbl Mag Case - Dbl Row Trad Cordura		\$40.45
44A058BK	Magazine/Folding Knife Case-.380 Mag, Subcompact 9 mm		\$16.95
44A150BK	Open Top Single Cuff Case		\$16.95
44A151BK	Compact Cuff Case		\$18.45
44A152BK	Double Cuff Case		\$23.95
44A153BK	Single Cuff Case		\$18.95
44A250BK	Light Case-SureFire® 6P, Streamlight® Scorpion® & Strion®		\$20.45
44A251BK	Stinger™ Light Case		\$18.95
44A252BK	Stinger XT™ Light Case		\$19.95
44A350BK	Latex Glove Case (Holds 1 Pair)		\$15.45
44A351BK	Latex Glove Case (Holds 2 Pairs)		\$18.95
44A450BK	Universal Radio Carrier (Fixed Belt Loop)		\$28.95
44A451BK	Universal Radio Carrier (Swivel Belt Loop)		\$38.95
44A455BK	Microphone Carrier for Epaulet		\$10.95
44A550BK	Chemical Agent Cases Large (MK4)		\$21.45
44A551BK	Chemical Agent Cases Medium (MK3)		\$18.45
44A650BK	Silent Key Holder		\$19.95
44A651BK	Open Key Holder		\$12.95
44A750BK	Expandable Baton Case		\$17.95
44B350BK	Nylon Belt Keepers Fit 2" Belts (Set of 4)		\$19.95
44B351BK	Nylon Belt Keepers Fit 2.25" Belts (Set of 4)		\$19.95



DUTY & PROTECTIVE **KNEE & ELBOW PADS**



TRIDENT ELBOW PAD

- Sizes: One size fits all
- 600 denier nylon carrier
- Injection molded FlexCap shell
- Closed cell, impact resistant foam padding
- Elastic straps for maximum mobility
- Strap retention loops
- QD hook and post closure system
- No slip tri-glide buckles for quick and easy adjustments

PART NUMBER	DESCRIPTION	COLOR	MSRP	MTO
EP03BKOS	Trident Elbow Pads	Black	\$24.95	
EP03CTOS	Trident Elbow Pads	Coyote Tan	\$24.95	MTO
EP03ODOS	Trident Elbow Pads	Olive Drab	\$24.95	MTO



TRIDENT KNEE PAD

- Sizes: One size fits all
- 600 denier nylon carrier
- Injection molded FlexCap shell
- Closed cell foam padding
- Heavy duty elastic top strap for maximum mobility
- Static nylon bottom strap reduces slippage
- Strap retention loops

PART NUMBER	DESCRIPTION	COLOR	MSRP	MTO
KP03ODOS	Trident Knee Pads	Olive Drab	\$35.95	MTO
KP03CTOS	Trident Knee Pads	Coyote Tan	\$35.95	MTO
KP03BKOS	Trident Knee Pads	Black	\$35.95	



ADVANCED TACTICAL KNEE PADS V.2

- Closed-cell foam padding for shock resistance and little or no moisture retention
- Contoured interior ledges prevent pads from slipping downward.
- 600 denier nylon shell
- Injection-molded flex cap design
- Minimizes gap between bottom of cap and nylon carrier when flexed
- Padded side extensions for additional comfort and improved strap positioning
- Hook & loop elastic straps keep pad in place

PART NUMBER	DESCRIPTION	COLOR	MSRP	MTO	NSN
808300BK	Advanced Tactical Knee Pads V.2	Black	\$28.95		
808300OD	Advanced Tactical Knee Pads V.2	Olive Drab	\$26.45	MTO	4240-01-573-3629



ADVANCED TACTICAL ELBOW PADS V.2

- Closed-cell foam padding provides excellent shock resistance and little or no moisture retention
- 600 denier nylon shell
- Non-slip, flexible, molded polyurethane cap
- Contoured interior ledge prevent pad slippage
- Hook & loop elastic straps keep pad in place

PART NUMBER	DESCRIPTION	COLOR	MSRP
802600BK	Advanced Tactical Elbow Pads V.2	Black	\$18.95





APPAREL



- HEADWEAR
- SHIRTS
- FOOTWEAR
- GLOVES



APPAREL HEADWEAR



TRIDENT FLEXFIT® CAP

- Sizes: One size fits all
- Body: 63% Polyester / 34% Cotton / 3% PU Spandex
- Mesh: 95% Polyester / 5% PU Spandex
- Fully adjustable FlexFit elastic headband for maximum comfort
- No-Button crown for added comfort when worn with over-ear protection
- Leather patch Trident applique

PART NUMBER	DESCRIPTION	COLOR	MSRP
EC12BMOS	Trident FlexFit Snapback Cap	MultiCam Black	\$24.95
EC12GROS	Trident FlexFit Snapback Cap	Graphite	\$24.95



LIGHTWEIGHT NOMEX® BALACLAVA

- Sizes: One size fits all
- 6-oz Nomex® material provides lightweight flash and flame resistance
- Internal flat-seam stitching reduces helmet irritation
- 18" head-to-neck coverage

PART NUMBER	DESCRIPTION	COLOR	MSRP
333005OD	Lightweight Balaclava	Olive Drab	\$19.45
333005CT	Lightweight Balaclava	Coyote Tan	\$19.45
333005BK	Lightweight Balaclava	Black	\$19.45





TACTICAL SHEMAGH

- Sizes: One size fits all
- Dimensions: 44" x 44" (112 cm x 112 cm)
- Body: 100% Cotton
- Traditional desert headwear provides protection to the neck and head from the sun and debris

PART NUMBER	DESCRIPTION	COLOR	MSRP	NSN
330005CT	Tactical Shemagh	Coyote Tan/Black	\$20.45	8415-01-613-1277
330005OD	Tactical Shemagh	Olive Drab/Black	\$20.45	8415-01-591-9066





APPAREL SHIRTS



PART NUMBER	DESCRIPTION	COLOR	SIZE	MSRP
GT12NA2XL	Trident Thin Blue Line Logo T-Shirt	Navy	2 XL	\$29.95
GT12NALG	Trident Thin Blue Line Logo T-Shirt	Navy	LG	\$29.95
GT12NAMD	Trident Thin Blue Line Logo T-Shirt	Navy	MD	\$29.95
GT12NASM	Trident Thin Blue Line Logo T-Shirt	Navy	SM	\$29.95
GT12NAXL	Trident Thin Blue Line Logo T-Shirt	Navy	XL	\$29.95



PART NUMBER	DESCRIPTION	COLOR	SIZE	MSRP
GT14TG2XL	Trident Star Logo T-Shirt	Gray	2 XL	\$29.95
GT14TGLG	Trident Star Logo T-Shirt	Gray	LG	\$29.95
GT14TGMD	Trident Star Logo T-Shirt	Gray	MD	\$29.95
GT14TGSM	Trident Star Logo T-Shirt	Gray	SM	\$29.95
GT14TGXL	Trident Star Logo T-Shirt	Gray	XL	\$29.95



PART NUMBER	DESCRIPTION	COLOR	SIZE	MSRP
GT10TG2XL	Trident Flag Logo T-Shirt	Gray	2XL	\$29.95
GT10TGLG	Trident Flag Logo T-Shirt	Gray	Large	\$29.95
GT10TGMD	Trident Flag Logo T-Shirt	Gray	MD	\$29.95
GT10TGSM	Trident Flag Logo T-Shirt	Gray	SM	\$29.95
GT10TGXL	Trident Flag Logo T-Shirt	Gray	XL	\$29.95



PART NUMBER	DESCRIPTION	COLOR	SIZE	MSRP
GT11BK2XL	Trident TNL Flag Logo T-Shirt	Black	2XL	\$29.95
GT11BKLG	Trident TNL Flag Logo T-Shirt	Black	LG	\$29.95
GT11BKMD	Trident TNL Flag Logo T-Shirt	Black	MD	\$29.95
GT11BKSM	Trident TNL Flag Logo T-Shirt	Black	SM	\$29.95
GT11BKXL	Trident TNL Flag Logo T-Shirt	Black	XL	\$29.95



APPAREL FOOTWEAR



8" DESERT OPS BOOT

- Rugged nylon and suede leather construction
- Vibram® Outsole with large, open lugs for maximum comfort and traction
- DRI-LEX® liner wicks away moisture to keep feet dry
- OrthoLite™ foam insoles are anti-microbial and machine washable
- Agion® scent-control finish on the liner mitigates foot odor
- Steel shank provides additional support when under load
- Fully gusseted tongue keeps out debris
- Abrasion resistant toe and heel reinforcements

PART NUMBER	DESCRIPTION	COLOR	MSRP	MTO
BT05CY13W	Desert Ops Boot 13 Wide	Coyote 498	\$163.45	MTO
BT05CY10W	Desert Ops Boot 10 Wide	Coyote 498	\$163.45	MTO
BT05CY115M	Desert Ops Boot 11.5 Medium	Coyote 498	\$163.45	MTO
BT05CY115W	Desert Ops Boot 11.5 Wide	Coyote 498	\$163.45	MTO
BT05CY11M	Desert Ops Boot 11 Medium	Coyote 498	\$163.45	MTO
BT05CY10M	Desert Ops Boot 10 Medium	Coyote 498	\$163.45	MTO
BT05CY13M	Desert Ops Boot 13 Medium	Coyote 498	\$163.45	MTO
BT05CY12M	Desert Ops Boot 12 Medium	Coyote 498	\$163.45	MTO
BT05CY105M	Desert Ops Boot 10.5 Medium	Coyote 498	\$163.45	MTO
BT05CY09M	Desert Ops Boot 9 Medium	Coyote 498	\$163.45	MTO
BT05CY14M	Desert Ops Boot 14 Medium	Coyote 498	\$163.45	MTO
BT05CY095M	Desert Ops Boot 9.5 Medium	Coyote 498	\$163.45	MTO
BT05CY08M	Desert Ops Boot 8 Medium	Coyote 498	\$163.45	MTO
BT05CY085M	Desert Ops Boot 8.5 Medium	Coyote 498	\$163.45	MTO
BT05CY09W	Desert Ops Boot 9 Wide	Coyote 498	\$163.45	MTO



6" TRIDENT ULTRALITE BOOT

- Lightweight 600 denier ballistic nylon and suede leather construction
- Phylon midsole provides superior lightweight cushioning
- OrthoLite™ foam insoles are anti-microbial and machine washable
- Agion® scent-control finish on the liner mitigates foot odor
- NATO speed lacing system

PART NUMBER	DESCRIPTION	COLOR	MSRP	MTO
BT06BK055M	Trident UltraLite Boot 5.5 Medium	Black	\$129.95	MTO
BT06BK05M	Trident UltraLite Boot 5 Medium	Black	\$129.95	MTO
BT06BK065M	Trident UltraLite Boot 6.5 Medium	Black	\$129.95	MTO
BT06BK06M	Trident UltraLite Boot 6 Medium	Black	\$129.95	MTO
BT06BK070M	Trident UltraLite Boot 7 Medium	Black	\$129.95	MTO
BT06BK075M	Trident UltraLite Boot 7.5 Medium	Black	\$129.95	MTO
BT06BK080M	Trident UltraLite Boot 8 Medium	Black	\$129.95	MTO
BT06BK085M	Trident UltraLite Boot 8.5 Medium	Black	\$129.95	MTO
BT06BK090M	Trident UltraLite Boot 9 Medium	Black	\$129.95	MTO
BT06BK095M	Trident UltraLite Boot 9.5 Medium	Black	\$129.95	MTO
BT06BK100M	Trident UltraLite Boot 10 Medium	Black	\$129.95	MTO
BT06BK105M	Trident UltraLite Boot 10.5 Medium	Black	\$129.95	MTO
BT06BK110M	Trident UltraLite Boot 11 Medium	Black	\$129.95	MTO
BT06BK115M	Trident UltraLite Boot 11.5 Medium	Black	\$129.95	MTO
BT06BK120M	Trident UltraLite Boot 12 Medium	Black	\$129.95	MTO
BT06BK130M	Trident UltraLite Boot 13 Medium	Black	\$129.95	MTO
BT06BK140M	Trident UltraLite Boot 14 Medium	Black	\$129.95	MTO
BT06CY055M	Trident UltraLite Boot 5.5 Medium	Coyote 498	\$129.95	MTO
BT06CY05M	Trident UltraLite Boot 5 Medium	Coyote 498	\$129.95	MTO
BT06CY065M	Trident UltraLite Boot 6.5 Medium	Coyote 498	\$129.95	MTO
BT06CY06M	Trident UltraLite Boot 6 Medium	Coyote 498	\$129.95	MTO
BT06CY070M	Trident UltraLite Boot 7 Medium	Coyote 498	\$129.95	MTO
BT06CY075M	Trident UltraLite Boot 7.5 Medium	Coyote 498	\$129.95	MTO
BT06CY080M	Trident UltraLite Boot 8 Medium	Coyote 498	\$129.95	MTO
BT06CY085M	Trident UltraLite Boot 8.5 Medium	Coyote 498	\$129.95	MTO
BT06CY090M	Trident UltraLite Boot 9 Medium	Coyote 498	\$129.95	MTO
BT06CY095M	Trident UltraLite Boot 9.5 Medium	Coyote 498	\$129.95	MTO
BT06CY100M	Trident UltraLite Boot 10 Medium	Coyote 498	\$129.95	MTO
BT06CY105M	Trident UltraLite Boot 10.5 Medium	Coyote 498	\$129.95	MTO
BT06CY110M	Trident UltraLite Boot 11 Medium	Coyote 498	\$129.95	MTO
BT06CY115M	Trident UltraLite Boot 11.5 Medium	Coyote 498	\$129.95	MTO
BT06CY120M	Trident UltraLite Boot 12 Medium	Coyote 498	\$129.95	MTO
BT06CY130M	Trident UltraLite Boot 13 Medium	Coyote 498	\$129.95	MTO
BT06CY140M	Trident UltraLite Boot 14 Medium	Coyote 498	\$129.95	MTO





APPAREL GLOVES



S.O.L.A.G.® STEALTH GLOVE

- Touch screen compatible for cell phones
- D30® impact foam protects knuckles
- Nomex® and Kevlar® protects hand from flash/flare and cuts
- Molded TPR hard knuckle cover

PART NUMBER	DESCRIPTION	SIZE	COLOR	MSRP
GT008BK2XL	S.O.L.A.G. Stealth Glove	2XL	Black	\$95.95
GT008BKLG	S.O.L.A.G. Stealth Glove	LG	Black	\$95.95
GT008BKMD	S.O.L.A.G. Stealth Glove	MD	Black	\$95.95
GT008BKSM	S.O.L.A.G. Stealth Glove	SM	Black	\$95.95
GT008BKXL	S.O.L.A.G. Stealth Glove	XL	Black	\$95.95
GT008TN2XL	S.O.L.A.G. Stealth Glove	2XL	Coyote	\$95.95
GT008TNLG	S.O.L.A.G. Stealth Glove	LG	Coyote	\$95.95
GT008TNMD	S.O.L.A.G. Stealth Glove	MD	Coyote	\$95.95
GT008TNSM	S.O.L.A.G. Stealth Glove	SM	Coyote	\$95.95
GT008TNXL	S.O.L.A.G. Stealth Glove	XL	Coyote	\$95.95



Black Coyote



S.O.L.A.G.® RECON GLOVE

- Touch screen compatible for cell phones
- D30® impact foam protects knuckles
- Nomex® and Kevlar® protects hand from flash/flare and cuts

PART NUMBER	DESCRIPTION	SIZE	COLOR	MSRP
GT007BK2XL	S.O.L.A.G. Recon Glove	2XL	Black	\$81.95
GT007BKLG	S.O.L.A.G. Recon Glove	LG	Black	\$81.95
GT007BKMD	S.O.L.A.G. Recon Glove	MD	Black	\$81.95
GT007BKSM	S.O.L.A.G. Recon Glove	SM	Black	\$81.95
GT007BKXL	S.O.L.A.G. Recon Glove	XL	Black	\$81.95
GT007TN2XL	S.O.L.A.G. Recon Glove	2XL	Coyote	\$81.95
GT007TNLG	S.O.L.A.G. Recon Glove	LG	Coyote	\$81.95
GT007TNMD	S.O.L.A.G. Recon Glove	MD	Coyote	\$81.95
GT007TNSM	S.O.L.A.G. Recon Glove	SM	Coyote	\$81.95
GT007TNXL	S.O.L.A.G. Recon Glove	XL	Coyote	\$81.95



Black Coyote



S.O.L.A.G.® INSTINCT FULL GLOVE

- Touch screen compatible for cell phones
- D30® impact foam protects knuckles

PART NUMBER	DESCRIPTION	SIZE	COLOR	MSRP
GT006BK2XL	S.O.L.A.G. Instinct Full Glove	2XL	Black	\$47.95
GT006BKLG	S.O.L.A.G. Instinct Full Glove	LG	Black	\$47.95
GT006BKMD	S.O.L.A.G. Instinct Full Glove	MD	Black	\$47.95
GT006BKSM	S.O.L.A.G. Instinct Full Glove	SM	Black	\$47.95
GT006BKXL	S.O.L.A.G. Instinct Full Glove	XL	Black	\$47.95



Black

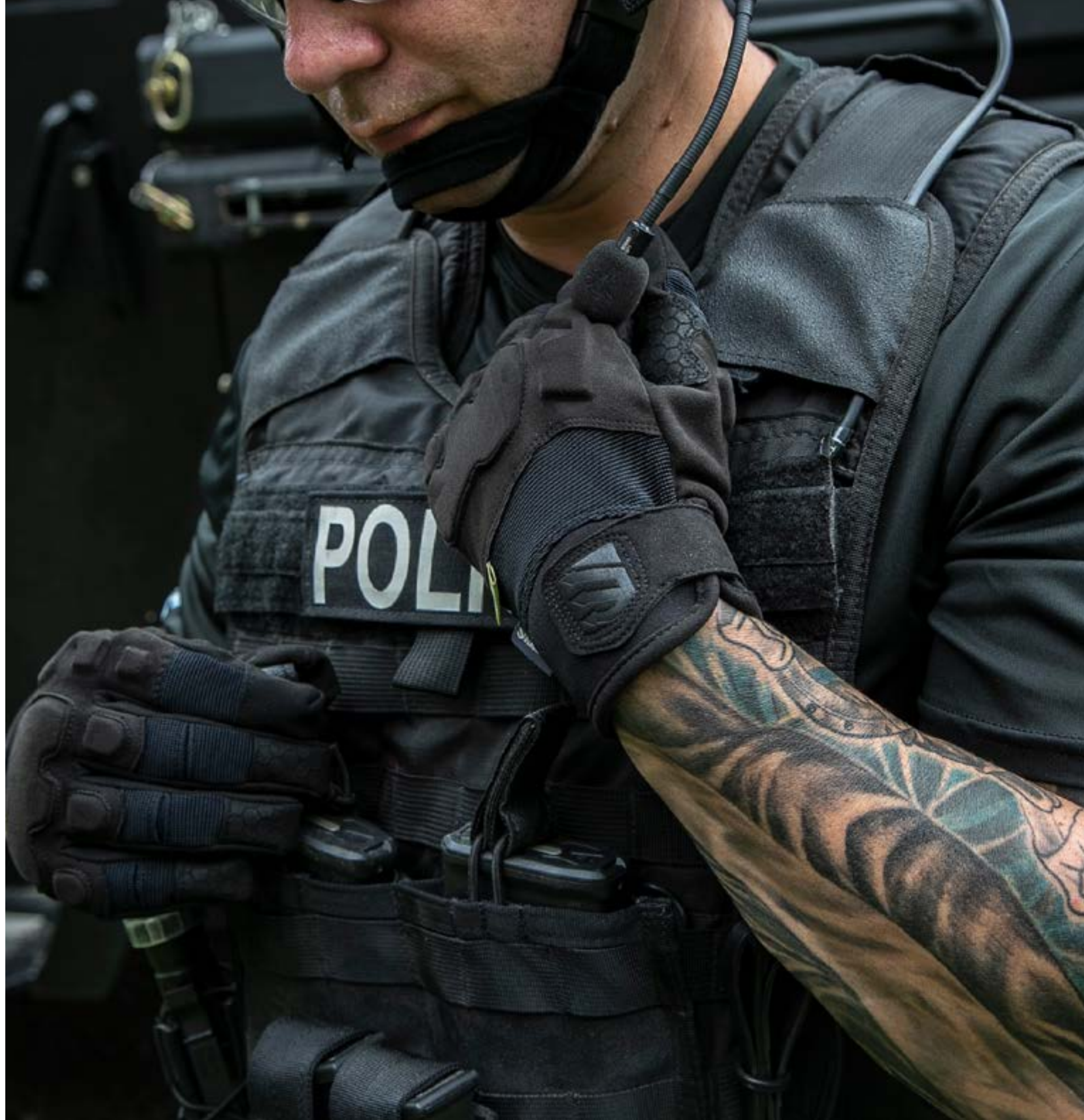



S.O.L.A.G.® INSTINCT HALF GLOVE

- Half fingers for smooth/no catch finger grip
- D30® impact foam protects knuckles

PART NUMBER	DESCRIPTION	SIZE	COLOR	MSRP
GT005BK2XL	S.O.L.A.G. Instinct Half Glove	2XL	Black	\$40.95
GT005BKLG	S.O.L.A.G. Instinct Half Glove	LG	Black	\$40.95
GT005BKMD	S.O.L.A.G. Instinct Half Glove	MD	Black	\$40.95
GT005BKSM	S.O.L.A.G. Instinct Half Glove	SM	Black	\$40.95
GT005BKXL	S.O.L.A.G. Instinct Half Glove	XL	Black	\$40.95



Black



A.V.I.A.T.O.R.® COMMANDO

- Touch screen compatible for cell phones
- Nomex® construction resists flash and flame
- Seamless index finger for no catch trigger finger

PART NUMBER	DESCRIPTION	SIZE	COLOR	MSRP
GT003BK2XL	A.V.I.A.T.O.R. Commando	2XL	Black	\$55.45
GT003BKLG	A.V.I.A.T.O.R. Commando	LG	Black	\$55.45
GT003BKMD	A.V.I.A.T.O.R. Commando	MD	Black	\$55.45
GT003BKSM	A.V.I.A.T.O.R. Commando	SM	Black	\$55.45
GT003BKXL	A.V.I.A.T.O.R. Commando	XL	Black	\$55.45
GT003TN2XL	A.V.I.A.T.O.R. Commando	2XL	Coyote	\$55.45
GT003TNLG	A.V.I.A.T.O.R. Commando	LG	Coyote	\$55.45
GT003TNMD	A.V.I.A.T.O.R. Commando	MD	Coyote	\$55.45
GT003TNSM	A.V.I.A.T.O.R. Commando	SM	Coyote	\$55.45
GT003TNXL	A.V.I.A.T.O.R. Commando	XL	Coyote	\$55.45

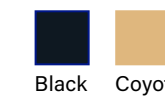

Black Coyote



A.V.I.A.T.O.R.® GLOVE

- Touch screen compatible for cell phones
- Nomex® construction resists flash and flame
- Seamless index finger for no-catch trigger finger

PART NUMBER	DESCRIPTION	SIZE	COLOR	MSRP
GT009BK2XL	A.V.I.A.T.O.R. Glove	2XL	Black	\$51.45
GT009BKLG	A.V.I.A.T.O.R. Glove	LG	Black	\$51.45
GT009BKMD	A.V.I.A.T.O.R. Glove	MD	Black	\$51.45
GT009BKSM	A.V.I.A.T.O.R. Glove	SM	Black	\$51.45
GT009BKXL	A.V.I.A.T.O.R. Glove	XL	Black	\$51.45



Black



P.A.T.R.O.L.® ELITE GLOVE

- Touch screen compatible for cell phones
- Embossed grip print on palm for dexterity
- Watch-compatible cuff for less bulk and easy read

PART NUMBER	DESCRIPTION	SIZE	COLOR	MSRP
GP002BK2XL	P.A.T.R.O.L. Elite Glove	2XL	Black	\$30.95
GP002BKLG	P.A.T.R.O.L. Elite Glove	LG	Black	\$30.95
GP002BKMD	P.A.T.R.O.L. Elite Glove	MD	Black	\$30.95
GP002BKSM	P.A.T.R.O.L. Elite Glove	SM	Black	\$30.95
GP002BKXL	P.A.T.R.O.L. Elite Glove	XL	Black	\$30.95



Black



F.U.R.Y.® UTILITARIAN GLOVE

- Touch screen compatible for cell phones
- Silicone grip print on palm for dexterity
- Breathable perforated palm for cooling

PART NUMBER	DESCRIPTION	SIZE	COLOR	MSRP
GT001BK2XL	F.U.R.Y. Utilitarian Glove	2XL	Black	\$29.95
GT001BKLG	F.U.R.Y. Utilitarian Glove	LG	Black	\$29.95
GT001BKMD	F.U.R.Y. Utilitarian Glove	MD	Black	\$29.95
GT001BKSM	F.U.R.Y. Utilitarian Glove	SM	Black	\$29.95
GT001BKXL	F.U.R.Y. Utilitarian Glove	XL	Black	\$29.95



Black



P.A.T.R.O.L.® BARRICADE GLOVE

- Touch screen compatible for cell phones
- Kevlar® construction resists cuts
- Compression-molded neoprene protects knuckles

PART NUMBER	DESCRIPTION	SIZE	COLOR	MSRP
GP001BK2XL	P.A.T.R.O.L. Barricade Glove	2XL	Black	\$45.95
GP001BKLG	P.A.T.R.O.L. Barricade Glove	LG	Black	\$45.95
GP001BKMD	P.A.T.R.O.L. Barricade Glove	MD	Black	\$45.95
GP001BKSM	P.A.T.R.O.L. Barricade Glove	SM	Black	\$45.95
GP001BKXL	P.A.T.R.O.L. Barricade Glove	XL	Black	\$45.95



Black



F.U.R.Y.® PRIME GLOVE

- Touch screen compatible for cell phones
- Silicone grip print on palm for dexterity
- Sonic-welded, molded TPR protects back of hand

PART NUMBER	DESCRIPTION	SIZE	COLOR	MSRP
GT002BK2XL	F.U.R.Y. Prime Glove	2XL	Black	\$38.95
GT002BKLG	F.U.R.Y. Prime Glove	LG	Black	\$38.95
GT002BKMD	F.U.R.Y. Prime Glove	MD	Black	\$38.95
GT002BKSM	F.U.R.Y. Prime Glove	SM	Black	\$38.95
GT002BKXL	F.U.R.Y. Prime Glove	XL	Black	\$38.95
GT002TN2XL	F.U.R.Y. Prime Glove	2XL	Coyote 499	\$38.95
GT002TNLG	F.U.R.Y. Prime Glove	LG	Coyote 499	\$38.95
GT002TNMD	F.U.R.Y. Prime Glove	MD	Coyote 499	\$38.95
GT002TNSM	F.U.R.Y. Prime Glove	SM	Coyote 499	\$38.95
GT002TNXL	F.U.R.Y. Prime Glove	XL	Coyote 499	\$38.95



Black Coyote



BAGS & PACKS



- BAGS
- PACKS
- RANGE BAGS & GUN CASES



BAGS & PACKS

BAGS



MOBILE OPERATION BAG

- Constructed of 1000 denier nylon with reinforced stitching
- Full wraparound carry handles for superior weight support
- High-quality YKK® zippers with easy-grip pull tabs
- Two padded, detachable shoulder straps
- External lockdown zipper flap
- Heavy-duty D-rings for securing external items and shoulder straps
- Dimensions: Total: 27"L x 14"W x 10"D = 5,500 cu. in.
- Large pocket: 24"L x 12"W x 3"D
- Two small pockets: 12"L x 12"W x 3"D

PART NUMBER	DESCRIPTION	COLOR	MSRP	NSN
20MOB3BK	Mobile Operation Bag, Large	Black	\$130.45	8465-01-517-6320



ENHANCED TACTICAL ROPE BAG

- Constructed of Type 4 nylon webbing
- Holds up to 200 feet of rope (rope not included)
- Drawstring sleeve for full bag closure
- Drawstring pocket holds excess drawstring
- Quick-release buckle belt attachment
- Grommets on bottom of bag for drainage
- External pocket for carabiners
- Quick disconnect leg straps with high-visibility red pull tabs
- Dimensions: 22"L x 5.5"W x 8"D

PART NUMBER	DESCRIPTION	COLOR	MSRP	NSN
20TR03BK	Enhanced Tactical Rope Bag	Black	\$71.45	8465-01-545-6007



CROWD CONTROL BAG

- Constructed of 1000 denier nylon with reinforced stitching
- Full wraparound carry handles for superior weight support
- Adjustable, removable shoulder strap
- High-quality YKK® zippers with easy-grip pull tabs
- Reinforced with polymer stiffeners
- ID panel on front pocket
- Padded helmet compartment
- External pouches and straps to secure baton or flashlight
- Dimensions: Total: 13"L x 11"W x 35"D = 5,005 cu. in.
- Main compartment: 21.5"L x 11"W x 13"D
- Helmet compartment: 13.5"L x 11"W x 13"D

PART NUMBER	DESCRIPTION	COLOR	MSRP
20CC00BK	Crowd Control Bag	Black	\$104.45







CZ GEAR BAG

- Constructed of 1000 denier nylon with reinforced stitching
- Full wraparound carry handles for superior weight support
- High-quality YKK® zippers with easy-grip pull tabs
- Adjustable shoulder strap with reversible, non-slip shoulder pad
- Dimensions: Total: 33.5"L x 16"W x 15"D = 8,040 cu. in.

PART NUMBER	DESCRIPTION	COLOR	MSRP	NSN
20C200BK	CZ Gear Bag	Black	\$96.95	8465-01-517-6330



A.L.E.R.T.™ 5 BAG

- Constructed of 1000 denier nylon with reinforced stitching
- External compression straps stabilize load
- Hideaway pull handle and full wraparound carry handles for superior weight support
- Removable daisy-chain handle
- Large U-shaped, hinge-type lid for easy access
- Multiple heavy duty D-rings for securing external/internal items or palletizing
- Two padded end-cap handles for two-person carry
- Durable inline-skate wheels and reinforced corners and stiffeners on bottom
- Multiple rows of S.T.R.I.K.E.® webbing for attaching pouches or accessories
- Large 33" x 14" weapon sleeve with heavy padding to protect long guns
- Three external clear window pockets for manifesting, content inventory or identification
- Dimensions: Total: 35"L x 21.5"W x 17"D = 9,684.5 cu. in.
- Main compartment: 34"L x 18"W x 14"D = 8,568 cu. in.
- External compartment: 29"L x 11"W x 3.5"D = 1,116.5 cu. in.

PART NUMBER	DESCRIPTION	COLOR	MSRP
20LO05BK	A.L.E.R.T. 5 Bag	Black	\$448.45



A.L.E.R.T.™ BAG

- Constructed of 1000 denier nylon with reinforced stitching
- Hideaway pull handle and full wraparound carry handles for superior weight support
- Heavy-duty lockable YKK® zippers with easy-grip pull tabs
- Large U-shaped, hinge-type lid for easy access
- Two padded end-cap handles for two-person carry
- Nine internal mesh pouches for gear storage
- Four clear ID insert pockets (two on top and one at each end)
- Reinforced corners and stiffeners on bottom
- Comes with inline-skate wheels to aid in transport
- Dimensions: Total: 43L" x 15"W x 13"D = 8,385 cu. in.

PART NUMBER	DESCRIPTION	COLOR	MSRP	NSN
20LO03BK	A.L.E.R.T. Bag w/ wheels	Black	\$312.95	8465-01-517-6319



MEDIUM A.L.E.R.T.™ BAG

- Constructed of 1000 denier nylon with reinforced stitching
- Zippered mesh dividers in all compartments
- Top dual-access (from outside or inside) compartment
- External compression straps stabilize load
- Hideaway pull handle and full wraparound carry handles for superior weight support
- Heavy-duty lockable YKK® zippers with easy-grip pulls
- Durable in-line skate wheels and reinforced corners
- Padded top pockets fold flat when not in use
- Dimensions: Total: 30"L x 16"W x 14"D = 6,720 cu. in.

PART NUMBER	DESCRIPTION	COLOR	MSRP
20LO04BK	Medium A.L.E.R.T. Bag	Black	\$250.45







ADVANCED TACTICAL BRIEFCASE

- Constructed of 1000 denier nylon with reinforced stitching and YKK® zippers with easy-grip pull tabs
- Waterproof internal lining protects contents
- Robust shoulder strap and carry handle
- Two hook & loop patches and removable vinyl ID window
- Padded hook & loop-secured laptop pocket
- External laptop access through waterproof zipper
- Three easy-access external pockets for cell phone, PDA, etc.
- Rear slot for pull-handle access (compatible with all wheeled luggage)
- Clear map case on inside of outer flap
- Five additional internal compartments
- Dimensions: 13"L x 16"W x 5"D = 610 cu. in./10 L

PART NUMBER	DESCRIPTION	COLOR	MSRP
61BC01BK	Advanced Tactical Briefcase	Black	\$168.95



ENHANCED PRO SHOOTER'S BAG

- Constructed of 1000 denier nylon with reinforced stitching
- Full wraparound carry handles for superior weight support
- Detachable shoulder strap with non-slip pad
- High-quality YKK® zippers with easy-grip pull tabs
- Zippered utility pockets at both ends
- Dimensions: Total: 7"L x 17"W x 12.5"D = 1488 cu. in.

PART NUMBER	DESCRIPTION	COLOR	MSRP
80SB06BK	Enhanced Pro Shooter's Bag	Black	\$143.45



PRO TRAINING BAG

- Constructed of 1000 denier nylon with reinforced stitching
- Full wraparound carry handles for superior weight support
- Adjustable, detachable shoulder strap with non-slip shoulder pad
- High-quality YKK® zippers with easy-grip pull tabs
- Two external mesh pockets
- Dimensions: Total: 19"L x 10"W x 12"D = 2280 cu. in.

PART NUMBER	DESCRIPTION	COLOR	MSRP
20SP00BK	Pro Training Bag	Black	\$127.95



GO BOX BAG

- Roll-up/down lid for easy access and secure transport
- Full wraparound carry handles for superior weight support
- Heavy-duty D-rings for shoulder strap attachment
- External utility pouch for mag loaders or other small items
- Loop patch to attach content identifiers
- Go Box 30 has the same volume as a single .30 cal ammo can (22GB01)
- Go Box 50 has the same volume as a single .50 cal ammo can (22GB02)
- Dimensions: Go Box 30: 7"L x 4.5"W x 10"D / Go Box 50: 8.5"L x 6"W x 10.5"D

PART NUMBER	DESCRIPTION	COLOR	MSRP
22GB02CT	Go Box 50 Ammo Bag	Coyote Tan	\$40.95
22GB01CT	Go Box 30 Ammo Bag	Coyote Tan	\$38.45





BAGS & PACKS

PACKS



TITAN™ PACK

- Constructed of heavy-duty 1000 denier nylon with reinforced stitching
- Includes 100-oz. Blackhawk® hydration reservoir
- Drink system protected by Microban® antimicrobial technology
- Bite Me® bite valve and patent-pending quick-disconnect system
- High-quality YKK® zippers and easy-grip pull tabs
- Multiple rows of S.T.R.I.K.E.® webbing for attaching pouches or accessories
- 3-D mesh back panel with frame
- Robust waist belt with additional S.T.R.I.K.E.® webbing
- Dual antenna ports and external hydration reservoir access
- Tie-down straps in main compartment and reinforced attachment system
- Includes Upright GP Pouch and Nalgene® Bottle Pouch
- Dimensions: Main Compartment: 20"L x 12.5"W x 7.5"D, Top Front Compartment: 14"L x 12.5"W x 2.75"D, Bottom Front Compartment: 12.5"L x 6"W x 3"D, Side Compartment: 8.25"L x 5"W x 3.75"D, Side Compartment: 9"L x 4"W x 2"D

PART NUMBER	DESCRIPTION	COLOR	MSRP	MTO	NSN
65TI00BK	Titan Pack	Black	\$360.95	MTO	
65TI00CT	Titan Pack	Coyote Tan	\$360.95	MTO	8465-01-585-6609



S.T.R.I.K.E.® CYCLONE™ PACK

- Constructed of 1000 denier nylon with reinforced stitching
- Includes 100-oz. Blackhawk® hydration reservoir
- Drink system protected by Microban® antimicrobial technology
- Bite Me® bite valve and patent-pending quick-disconnect system
- High-quality YKK® zippers and easy-grip pull tabs
- Multiple rows of S.T.R.I.K.E.® webbing for attaching pouches or accessories
- Tube cover conceals, insulates and protects water tube from sunlight
- Anodized D-rings and quick-cinch buckles for attaching pouches
- Reinforced waist belt with additional attachment points
- Padded, contour-fit shoulder straps with sternum strap
- Rubber drag handle and metal grommet at bottom of pack for drainage
- Large compartment with internal pouch for radio packs and three antenna ports with flaps
- Dimensions: Main Compartment: 19"L x 11"W x 5.5"D, Front-Top Compartment: 9.5"L x 7"W x 3"D, Front-Bottom Compartment: 11"L x 11.5"W x 3.5"D

PART NUMBER	DESCRIPTION	COLOR	MSRP	NSN
65SC00CT	S.T.R.I.K.E.® Cyclone Pack	Coyote Tan	\$209.95	8465-01-522-1026
65SC00OD	S.T.R.I.K.E.® Cyclone Pack	Olive Drab	\$209.95	8465-01-522-1025





S.T.R.I.K.E.® PREDATOR™ PACK

- Constructed of 1000 denier nylon with reinforced stitching
- Includes 100-oz. Blackhawk® hydration reservoir
- Drink system protected by Microban® antimicrobial technology
- Bite Me® bite valve and patent-pending quick-disconnect system
- High-quality YKK® zippers and easy-grip pull tabs
- Multiple rows of S.T.R.I.K.E.® webbing for attaching pouches or accessories
- Padded, contour-fit shoulder harness with sternum strap
- Reinforced drag/carry handle
- IVS™ (Intercooler Venting System) back panel for ventilation
- Compartment for second optional hydration reservoir
- Dimensions: Main Compartment: 16"L x 9.5"W x 2.5"D, Front Compartment: 9"L x 9.5"W x 2.5"D



PART NUMBER	DESCRIPTION	COLOR	MSRP	NSN
65SP00BK	S.T.R.I.K.E.® Predator Pack	Black	\$148.45	8465-01-517-7865

3-DAY ASSAULT™ PACK

- Constructed of 1000 denier nylon with reinforced stitching
- Accommodates 100-oz. hydration reservoir
- Sleeping bag straps, padded shoulder straps and heavy-duty D-rings for securing external items
- High-quality YKK® zippers and easy-grip pull tabs
- Reinforced drag/carry handle
- Removable elasticized sternum strap with silent release buckle and padded waist belt
- IVS™ (Intercooler Venting System) back panel for ventilation
- Dimensions: Main compartment: 20"L x 13"W x 6"D
Front compartment: 14.5"L x 12.5"W x 2.5"D
- Cubes: 2,000 cu. in. / 37 L



PART NUMBER	DESCRIPTION	COLOR	MSRP
603D00DE	3-Day Assault Pack	Coyote Tan	\$149.95
603D00BK	3-Day Assault Pack	Black	\$149.95

CYANE™ DYNAMIC PACK

- Constructed of denier nylon (solid colors) or CORDURA® nylon (MultiCam®)
- Removable 3-D mesh padded back panel and carry handle with lash loops on top of pack
- Six adjustable 3/4" compression straps
- Easy-grip zipper pulls and removable padded shoulder straps
- Multiple rows of S.T.R.I.K.E.® webbing: seven on back, four on each side, and three on the front
- One slash pocket on main compartment and two on front compartment
- Zippered pocket (84 cu. in.) on front compartment with two rows of S.T.R.I.K.E.® webbing
- Main compartment is 650 cu. in.) and beavertail-style compartment is 595 cu. in.
- Hydration pocket with three elastic-covered tube ports accommodates 100-oz. hydration reservoir
- Dimensions: 16.5"H x 8.5"W x 12"D, Main Compartment: 16.5"H x 8.5"W x 4.5"D



PART NUMBER	DESCRIPTION	COLOR	MSRP
60CD00BK	Cyane™ Dynamic Pack	Black	\$163.45
60CD00CT	Cyane™ Dynamic Pack	Coyote Tan	\$163.45

ULTRALIGHT 3-DAY ASSAULT PACK

- Constructed of lightweight, high-tenacity 210/330 denier nylon and 210 denier ripstop nylon (solid colors)
- Accommodates 100-oz. hydration reservoir
- High-quality YKK® zippers with easy-grip pull tabs
- Easy-access main compartment with front pocket and map pocket
- Multiple rows of S.T.R.I.K.E.® webbing for attaching pouches or accessories
- Four adjustable external compression straps accommodate various loadouts
- Five internal tie-down loops
- Padded shoulder straps and removable heavy duty waist belt
- Heavy-duty D-rings for securing external items
- Loop fastener on front for ID patch attachment
- Dimensions: Inner main compartment: 20"L x 13"W x 6"D Top-front pocket: 14.5"L x 12.5"W x 2.5"D
- Cubes: 2,000 cu. in. / 37 L



PART NUMBER	DESCRIPTION	COLOR	MSRP
603D08CT	Ultralight 3-Day Assault Pack	Coyote Tan	\$166.95
603D08BK	Ultralight 3-Day Assault Pack	Black	\$166.95



BLACKHAWK



SPECIAL OPERATIONS MEDICAL BACKPACK



- Constructed of 1000 denier nylon with reinforced stitching
 - Accommodates 100-oz. hydration reservoir
 - Heavy-duty lockable YKK® zippers with easy-grip pull tabs
 - Contour-padded shoulder straps and waist belt
 - Robust grab handle and metal grommet at bottom of pack for drainage
 - Adjustable external compression straps accommodate various loadouts
 - Internal pockets made of urethane-coated mesh
 - Individual medical gear compartments
 - Padded back and internal tri-fold flap
- Dimensions: 18"L x 13"W x 7.5"D = 2,225 cu. in.

PART NUMBER	DESCRIPTION	COLOR	MSRP	NSN
60MP00OD	Special Operations Medical Backpack	Olive Drab	\$208.45	6545-01-522-1030
60MP00DE	Special Operations Medical Backpack	Coyote Tan	\$208.45	6545-01-522-1017
60MP00BK	Special Operations Medical Backpack	Black	\$208.45	6545-01-522-1016



VELOCITY X3 JUMP PACK

- Constructed of 1000 denier nylon with reinforced stitching
- Quad-stitched seams and double-taped edges
- Accommodates 100-oz. hydration reservoir
- High-quality YKK® zippers and easy-grip pull tabs
- Multiple rows of S.T.R.I.K.E.® webbing for attaching pouches or accessories
- Removable heavy-duty waist belt with three rows of S.T.R.I.K.E.® webbing
- Removable, adjustable sternum strap and padded shoulder straps with dual-adjustment metal hardware
- Heavy-duty D-rings for securing external items
- Easy-access main compartment with front pocket and map pocket
- Four internal equipment tie-down straps, eight internal tie-down loops and eight external loops
- Two adjustable external compression straps with metal hardware
- Reinforced attachment system on bottom
- Dimensions: Main Compartment: 22"L x 13"W x 8.5"D / Top-Front Pocket: 18"L x 13"W x 2"D
- Cubes: 3290 cu. in.

PART NUMBER	DESCRIPTION	COLOR	MSRP
603D09CT	Velocity X3 Jump Pack	Coyote Tan	\$306.95





RAPIDFLEX™ MEDICAL LITTER

- Constructed of heavy-duty, impermeable PVC tarpaulin
- Rolls up into small bundle for easy storage and deployment
- Stabilizing torso strap is constructed of 2" nylon webbing and adjusts to 76" with side-release buckle
- Six durable 2" nylon web loop handles (two on each side and one drag handle at each end)
- Combined strength of all four handles exceeds 1700 lbs.
- Drag weight exceeds 1600 lbs.

PART NUMBER	DESCRIPTION	COLOR	MSRP	NSN
20ML00BK	RapidFlex™ Medical Litter	Black	\$57.45	6530-01-573-9585



FAST ATTACK TACTICAL LITTER

- Heavy-duty, impermeable PVC tarpaulin material
- Six durable 2" nylon web loop handles (two handles on each side and one drag handle at each end)
- Combined strength of all four handles exceeds 1900 lbs.
- Drag weight exceeds 1800 lbs.
- Stabilizing torso strap constructed of 2" nylon webbing and adjusts to 76" with side-release buckle
- Angled stabilizing leg straps constructed of 2" nylon webbing and adjust to 32" with side-release buckles

PART NUMBER	DESCRIPTION	COLOR	MSRP	NSN
20ML01BK	Fast Attack Tactical Litter	Black	\$78.45	6530-01-573-9600



MEDIC ROLL

- Constructed of durable 1000 denier nylon
- Full wraparound carry handles for superior weight support
- Internal pleated vinyl pockets to store medical supplies
- Dimensions: 37"L x 13.5"W

PART NUMBER	DESCRIPTION	COLOR	MSRP	NSN
20EMR1BK	Emergency Medic Roll	Black	\$50.95	8465-01-594-0574



S.T.O.M.P. II® MEDICAL COVERAGE PACK (JUMPABLE)



- Constructed of 1000 denier nylon with reinforced stitching
- Breathable closed-cell foam padding
- Accommodates two 100-oz. hydration reservoirs
- Webbing on underside for accessory packs or medic/sleeping rolls
- Adjustable shoulder straps, web belt and sternum strap
- Two robust grab handles and metal grommet at bottom of pack for drainage
- Adjustable external compression straps accommodate various loadouts
- Internal elastic stays and keepers
- External hook & loop strip
- Drop pouches with rigging for jumps
- Several flat netted zipper pockets
- Includes S.T.O.M.P.® Medical Pack Accessory Pouch with Red Handle and S.T.O.M.P.® Medical Pack Accessory Pouch with Blue Handle for storing medical supplies
- Dimensions: 20"L x 13"W x 6"D = 2,470 cu. in.

PART NUMBER	DESCRIPTION	COLOR	MSRP	NSN
60MP01OD	S.T.O.M.P. II Medical Coverage Pack	Olive Drab	\$354.95	6545-01-522-1031
60MP01DE	S.T.O.M.P. II Medical Coverage Pack	Coyote Tan	\$354.95	6545-01-522-1029
60MP01BK	S.T.O.M.P. II Medical Coverage Pack	Black	\$354.95	6545-01-522-1020



STINGRAY EDC

- Strong: EVA-molded side wings protect gear from jostles, bumps and drops
- Secure: Large, fleece-lined valuables pocket is deep enough to hold the largest smart phones
- Versatile: Loop-lined MOLLE in main compartment for easy attachment of pouches and other accessories
- Durable: YKK™ zippers with wide tabs for reliable opening and closing.

PART NUMBER	DESCRIPTION	COLOR	MSRP
60SR01BK	Stingray EDC Pack	Black	\$134.95
60SR01CT	Stingray EDC Pack	Coyote Tan	\$134.95



Black Tan





STAX 3-DAY

- Secure: Large, fleece-lined valuables pocket is deep enough to hold the largest smart phones
- Versatile: Loop-lined MOLLE in main compartment for easy attachment of pouches and other accessories
- Durable: YKK™ zippers with wide tabs for reliable opening and closing.

PART NUMBER	DESCRIPTION	COLOR	MSRP
60ST03BK	STAX 3-Day Pack	Black	\$159.95
60ST03CT	STAX 3-Day Pack	Coyote Tan	\$159.95



Black Tan



TIDAL RAVE PACK

- Includes 100-oz. Blackhawk hydration reservoir
- Drink system protected by Microban® antimicrobial technology
- Bite Me® bite valve and patent-pending quick-disconnect system
- Lightweight mesh shoulder harness
- Bungee retention system for extra clothes storage
- Capacity: 100 oz./3 L
- Weight: 14.1 oz.

PART NUMBER	DESCRIPTION	COLOR	MSRP
65TR00BK	Tidal Rave Pack	Black	\$70.45



BAGS & PACKS

RANGE BAGS & GUN CASES



DISCREET SOCOM PISTOL CASE

- Fully modular pouches for custom configurations
- .375" closed-cell foam padding for weapon protection
- TalonFlex™ plastic inserts on top and bottom for stiffness
- High-quality YKK® zippers and dual sliders with full wraparound carry handles
- Universal holster and barrel pouch, sound suppressor pouch, double mag pouch and UTL light pouch
- Dimensions: 10"L x 13"W x 2.5"D

PART NUMBER	DESCRIPTION	COLOR	SIZE	MSRP
66SS00BK	Discreet SOCOM Pistol Case	Black	10" x 2.5" x 13"	\$91.95



GUN RUG PISTOL POUCH

- Constructed of 1000 denier nylon
- .375" closed-cell foam padding for weapon protection
- High-quality YKK® zippers and dual sliders for security and full wraparound carry handles
- Internal padded divider for weapons and accessories and elastic keeper for extra magazines
- Dimensions: 12"L x 8"W

PART NUMBER	DESCRIPTION	COLOR	SIZE	MSRP	NSN
61GR01BK	Gun Rug Pistol Pouch	Black	12" x 8"	\$30.45	1095-01-517-6337



SPORTSTER® DELUXE RANGE BAG

- Removable gun rug pistol pouch with internal soft fabric to protect firearm
- Dual-density foam with internal open-cell foam for protection and external closed-cell foam for impacts
- Wraparound tactical web handles for superior weight support
- Heavy seam binding with two rows of locked stitching for durability
- Self-healing, heavy-duty, oversized coil zipper
- Integral pockets to hold two handguns
- Multiple internal pockets for organizing magazines or accessories
- Multiple rows of S.T.R.I.K.E.® webbing for attaching pouches or accessories
- Dimensions: 15" L x 11"H x 10"D

PART NUMBER	DESCRIPTION	COLOR	MSRP
74RB01BK	Sportster® Deluxe Range Bag	Black	\$62.45



SPORTSTER® SHOOTER'S BAG

- Constructed of tight-weave, heavyweight 600 denier polyester with thick PVC laminate for stability
- Dual-density foam with internal open-cell foam for protection and external closed-cell foam for impacts
- Two large dual-zippered compartments and one slash pocket
- Two internal pockets hold two handguns
- Internal mag pockets hold magazines securely
- Multiple rows of S.T.R.I.K.E.® webbing for attaching pouches or accessories
- Dimensions: 13" L x 9" H x 4.5" D

PART NUMBER	DESCRIPTION	COLOR	MSRP
73SB00BK	Sportster® Shooter's Bag	Black	\$36.45



SPORTSTER® PISTOL RANGE BAG

- Constructed of tight-weave, heavyweight 600 denier polyester with thick PVC laminate for stability
- Dual-density foam with internal open-cell foam for protection and external closed-cell foam for impacts
- Main internal pocket with dual-slider opening for easy access to contents
- Two external slash pockets hold magazines and other small items
- Includes two flannel-lined rugs to protect handgun inside main compartment
- Multiple rows of S.T.R.I.K.E.® webbing for attaching pouches or accessories
- Dimensions: 16" L x 9" H x 8" D

PART NUMBER	DESCRIPTION	COLOR	MSRP
74RB02BK	Sportster® Pistol Range Bag	Black	\$41.95



SHOTGUN CASE

- Constructed of durable 1000 denier nylon and .375" closed-cell foam
- Removable, adjustable shoulder strap with non-slip shoulder pad
- Designed to hold standard stock 18" to 22" barrels
- High-quality YKK® zippers and sliders
- Dual-slider zippered utility pocket and pouches

PART NUMBER	DESCRIPTION	COLOR	SIZE	MSRP
64SG43BK	Shotgun Case	Black	43" x 2" x 8"	\$104.45



RIFLE CASE

- Double-stitched seam taping on raw edges with Box X-anchor stitching on handles
- Full-opening zipper for shooting mat configuration
- High-quality YKK® zippers and sliders
- Removable foam inserts and four external mag pouches with adjustable lids

PART NUMBER	DESCRIPTION	COLOR	SIZE	MSRP
64RC34BK	34" Rifle Case	Black	34" x 2.5" x 11.5"	\$104.45
64RC37BK	37" Rifle Case	Black	37" x 2.5" x 11.5"	\$104.45
64RC41BK	41" Rifle Case	Black	41" x 2.5" x 11.5"	\$112.45



HOMELAND SECURITY DISCREET CASE

- Double-stitched seam taping on raw edges with Box-X anchor stitching on handles
- Zipper fully opens, so case can be utilized as a shooting mat
- Includes removable Triple M16 Mag Pouch

PART NUMBER	DESCRIPTION	COLOR	SIZE	MSRP	NSN
65DC22BK	MP5 Case	Black	22" x 2" x 10"	\$112.45	
65DC32BK	CAR15 Case	Black	32" x 2" x 13"	\$132.95	1080-01-563-5360
65DC35BK	CAR15/M4 Case	Black	35" x 2" x 10"	\$143.45	1005-01-607-4736
65DC40BK	M16 Case	Black	40" x 2" x 12"	\$156.45	1095-01-529-5775



SPORTSTER® PISTOL RUG

- Constructed of tight-weave, heavyweight 600 denier polyester with thick PVC laminate for stability
- Dual-density foam with internal open-cell foam for protection and external closed-cell foam for impacts
- Internal soft fabric protects firearm finish
- Wraparound tactical web handles for superior weight support
- Rugged tactical webbing on shoulder straps and contact points
- Heavy seam binding with two rows of locked stitching for durability
- Self-healing, heavy-duty, oversized coil zippers
- Fits most pistols and revolvers
- Dimensions: Medium: 12.5"L x 8"W x 1.25"D (74PR01) Large: 15"L x 8"W x 1.25"D (74PR02)

PART NUMBER	DESCRIPTION	COLOR	SIZE	MSRP
74PR01BK	Sportster® Pistol Rug -MD	Black	12.5" x 1.25" x 8"	\$11.95
74PR02BK	Sportster® Pistol Rug -LG	Black	15" x 1.25" x 8"	\$12.95



SPORTSTER® TACTICAL CARBINE/RIFLE CASE

- Tight-weave 600 denier polyester with thick PVC laminate and dual-density foam padding
- Holds Carbines and Rifles, see size chart for specific fit
- Four external mag pockets and two large accessory pockets for gear

PART NUMBER	DESCRIPTION	COLOR	SIZE	MSRP
74SG36BK	Sportster® Tactical Carbine/Rifle Case	Black	36" x 3" x 11.5"	\$41.95
74SG02BK	Sportster® Tactical Carbine/Rifle Case	Black	42.5" x 3" x 11.5"	\$44.95
74SG03BK	Sportster® Tactical Carbine/Rifle Case	Black	44" x 3" x 12.5"	\$47.95



SPORTSTER® SHOTGUN CASE

- Tight-weave 600 denier polyester with thick PVC laminate and dual-density foam padding
- Holds shotguns up to 52" long
- Multiple rows of S.T.R.I.K.E.® webbing for attaching pouches or accessories

PART NUMBER	DESCRIPTION	COLOR	MSRP
74SG01BK	Sportster® Shotgun Case	Black	\$26.45



SPORTSTER® SCOPED RIFLE CASE

- Tight-weave 600 denier polyester with thick PVC laminate and dual-density foam padding
- Holds scoped rifles up to 44" long (74SG44) or 48" long (74SG48)
- Multiple rows of S.T.R.I.K.E.® webbing for attaching pouches or accessories

PART NUMBER	DESCRIPTION	COLOR	SIZE	MSRP
74SG44BK	Sportster® 44" Scoped Rifle Case	Black	45" x 2" x 10"	\$29.45



SPORTSTER® MODULAR WEAPONS CASE

- Tight-weave 600 denier polyester with thick PVC laminate and dual-density foam padding
- Modular discreet case with removable divider
- Internal S.T.R.I.K.E.® webbing for attaching pouches or accessories
- Includes Muzzle Retainer and Weapon Retainer

PART NUMBER	DESCRIPTION	COLOR	SIZE	MSRP
74SG04BK	Sportster® Modular Weapons Case	Black	36" x 5" x 13"	\$71.45



STALKER DRAG MAT

- Constructed of durable 1000 denier nylon and closed-cell foam
- Removable, adjustable shoulder strap with non-slip shoulder pad
- Internal weapon-securing straps
- Elastic loops with protective flap hold 10 rounds of .308 ammo
- Internal data book pocket and open bottom design
- Dimensions: Closed 50.5"L x 9"W x 2"D

PART NUMBER	DESCRIPTION	COLOR	SIZE	MSRP	NSN
80DM00BK	Stalker Drag Mat	Black	50.5" x 2" x 9"	\$166.95	8465-01-517-7048
80DM00OD	Stalker Drag Mat	Olive Drab	50.5" x 2" x 9"	\$166.95	8465-01-517-7049



LONG GUN SNIPER DRAG BAG

- Constructed of durable 1000 denier nylon and closed-cell foam
- Full-opening zipper for shooting mat configuration
- High-quality YKK® zippers and sliders
- Detachable shoulder straps for muzzle-up or muzzle-down carry
- Reinforced drag handle and front/rear cargo pouches with internal straps
- Loops for ghillie attachment
- Internal weapon-securing straps and two internal utility pouches
- Dimensions: 51" L x 11" W x 3" D
Rear cargo pouch: 9.5" L x 12" W x 2" D
Front cargo pouch: 23" L x 8.5" W x 2" D

PART NUMBER	DESCRIPTION	COLOR	SIZE	MSRP
20DB01BK	Long Gun Drag Bag Black	Black	51" x 3" x 11"	\$297.45
20DB01DE	Long Gun Drag Bag COYOTE TAN	Coyote Tan	51" x 3" x 11"	\$297.45
20DB01OD	Long Gun Drag Bag Olive Drab	Olive Drab	51" x 3" x 11"	\$297.45

ACCESSORIES



- SLINGS & SLING MOUNTS
- LONG GUN ACCESSORIES
- ON-GUN COMPONENTS
- SHOOTING SUPPORT & KNIVES
- MISCELLANEOUS



ACCESSORIES

SLINGS & SLING MOUNTS



QUICK DISCONNECT SLICK

MULTIPOINT SLING

- Nylon weave construction designed for long hours of wear
- Quickly converts to multiple configurations with only one hand
- Rapid Adjustment Slider Buckle enables high-speed rifle transitions
- All-steel quick detach mounting points are built to last

PART NUMBER	DESCRIPTION	COLOR	MSRP
70MCFE05BK	Multi-Point Sling -Cushion Stretch - Free End	Black	\$59.95
70MCFE05CT	Multi-Point Sling -Cushion Stretch - Free End	Coyote Tan	\$59.95
70MFE04BK	Multi-Point Sling - Free End Slick	Black	\$49.95
70MFE04CT	Multi-Point Sling - Free End Slick	Coyote Tan	\$49.95
70MQD01BK	Multi-Point Quick Disconnect Sling -Slick	Black	\$69.95
70MQD01CT	Multi-Point Quick Disconnect Sling -Slick	Coyote Tan	\$69.95
70MQDS02BK	Multi-Point Quick Disconnect Sling -Stretch	Black	\$69.95
70MSH03BK	Multi-Point Sling - Snap Hook - Slick	Black	\$39.95
70MSH03CT	Multi-Point Sling - Snap Hook - Slick	Coyote Tan	\$39.95



QUICK DISCONNECT STRETCH



SNAP HOOK STRETCH



FREE END SLICK



QUICK DISCONNECT



SNAP HOOK



FREE END



SLACKHAWK
WEARABLE TACTICAL GEAR SLACKHAWK.COM



UNIVERSAL SINGLE-POINT SLING ADAPTER

- Ambidextrous design
- Firearm hangs flat against body
- Compatible with most conventional sling hooks
- Fits AR15/M4/M16 collapsible stocks (not compatible with some Colt rifles)

PART NUMBER	DESCRIPTION	COLOR	MSRP	NSN
70SM04BK	Universal Single-Point Sling Adapter	Black	\$30.45	1005-01-533-3432

SINGLE-POINT SLING ADAPTER

- Constructed of heavy-duty nylon webbing with robust metal D-rings
- Configures any weapon to accept a single-point sling

PART NUMBER	DESCRIPTION	COLOR	MSRP	NSN
70SA00BK	Single-Point Sling Adapter	Black	\$6.95	1005-01-589-9506



AR-15/M4 STORM™ SLING ADAPTER

- For use with AR-15/M4 rifles equipped with collapsible stocks
- Provides ambidextrous mounting points for STORM Slings™
- Simple add-on installation with no modification required
- Fits MIL-spec or commercial tubes

PART NUMBER	DESCRIPTION	COLOR	MSRP
71SA05BK	AR-15/M4 STORM Sling Adapter	Black	\$28.45

UNIVERSAL SWIFT SLING

- Three-point sling features a quick cam buckle for rapid one-hand adjustment
- Constructed of high-quality 1.25" nylon webbing
- Heavy duty tri-glide buckle, metal ring and single side-release buckle for quick detachment
- Adjustable, ambidextrous design for 60 possible configurations and quick shoulder transitions

PART NUMBER	DESCRIPTION	COLOR	MSRP
70GS17BK	Universal Swift Sling	Black	\$40.95





STORM™ SLING RS

- Constructed of high-quality 1.25" nylon webbing
- High-strength, smooth elliptical bungee for improved firearm agility and CQB tactics
- Rapid-release buckle for easy and safe sling removal
- Removable snap hook for quick and positive firearm attachment
- Integrated release buckle for convenient firearm attachment or removal
- Heavy-duty tri-glide buckle for proper fit

PART NUMBER	DESCRIPTION	COLOR	MSRP
70GS20BK	STORM™ Sling RS	Black	\$40.95



STORM™ SLING

- Single-point sling is constructed of high-strength 1.25" wide nylon webbing with an elliptical bungee
- Compressed tubular nylon sheathing limits bounce and enhances retention
- Elastic-encased MASH clip for quick, positive firearm attachment
- Heavy-duty tri-glide buckle, metal ring and single side-release buckle for quick attachment
- 4" flex for weapon agility and CQB tactics
- Adjusts from 46" to 64" in diameter to fit all body sizes and around bulky tactical vests or gear

PART NUMBER	DESCRIPTION	COLOR	MSRP	NSN
70GS12BK	STORM™ Sling	Black	\$34.45	1005-01-533-3425

STORM™ SLING QD

- Single-point sling adjusts from 30" to 50"
- Removable, elastic-encased MASH clip for quick, positive firearm attachment
- Robust bar tacking and box stitching for maximum strength
- Constructed of high-quality 1.25" wide nylon webbing
- Heavy-duty tri-glide buckle, metal ring and side-release buckle for quick firearm attachment

PART NUMBER	DESCRIPTION	COLOR	MSRP
70GS15BK	STORM™ Sling QD	Black	\$25.45



STORM™ SLING XT

- Single-point sling adjusts from 46" to 64" in diameter to fit all body sizes and around bulky vests or gear
- Elliptical bungee provides comfort and support
- Compressed tubular nylon sheathing limits bounce and enhances retention
- Constructed of high-quality 1.25" wide nylon webbing
- Removable, elastic-encased MASH clip for quick, positive firearm attachment
- Heavy-duty tri-glide buckle, metal ring and side-release buckle for quick firearm attachment
- 4" flex for weapon agility and CQB tactics
- Robust bar tacking and box stitching for maximum strength

PART NUMBER	DESCRIPTION	COLOR	MSRP	NSN
70GS16BK	STORM™ Sling XT	Black	\$41.95	1005-01-581-6896



STORM™ SLING XT/QD AND SUB-GUN SLING QUICK DISCONNECT ATTACHMENT

- Extra attachment assembly for multiple firearms

PART NUMBER	DESCRIPTION	COLOR	MSRP
70SA02BK	STORM™ Sling XT/QD - Quick Disconnect Attachment	Black	\$15.45



QD SWIVEL SLING ADAPTER

- Heavy-duty QD swivel
- Compatible with STORM™ Sling RS, QD, XT and Sub-Gun Sling

PART NUMBER	DESCRIPTION	COLOR	MSRP
70SA03BK	QD Swivel Sling Adapter	Black	\$22.45



MOUNTAIN SLING

- Constructed of high-quality 1.25" wide nylon webbing
- Non-slip backing keeps sling in place
- Two all-steel, blued LOK-DOWN™ swivels for easy attachment
- One-hand operation

PART NUMBER	DESCRIPTION	COLOR	MSRP
73SM00BK	Mountain Sling	Black	\$21.95



LOK-DOWN™ SWIVEL SET

- Includes two detachable swivels
- Positive locking mechanism

PART NUMBER	DESCRIPTION	COLOR	MSRP
70SW07BK	LOK-DOWN Swivel Set 1"	Black	\$12.95
70SW08BK	LOK-DOWN Swivel Set 1.25"	Black	\$14.45



METAL 1" HEAVY-DUTY SNAP HOOKS

- Robust construction
- Set of two

PART NUMBER	DESCRIPTION	COLOR	MSRP
98HM00BK	Metal 1" Heavy-Duty Snap Hooks	Black	\$16.45



PUSH BUTTON DETACHABLE

- Flush-mount front and rear bases for stud-free profile with sling and swivels removed
- Bases glue in place (no screws required)

PART NUMBER	DESCRIPTION	MSRP
70SW16BK	Push Button Swivel Set 1"	\$20.45



DIETER CQD SLING WITH SLING COVER

- Hybrid single-point/two-point sling incorporates heavy duty elastic
- Constructed of 1.25" wide T-13 webbing that is softer than standard webbing
- Adjustable design to fit all operators
- Metal snap hooks attach to most weapon systems, brackets or attachment buckles



PART NUMBER	DESCRIPTION	COLOR	MSRP	NSN
71CQS1BK	Dieter CQD® Sling with Sling Cover	Black	\$45.95	8415-01-504-3087

TACTICAL RELEASABLE S.T.R.I.K.E.® SLING

- Heavy-duty elliptical bungee and tubular nylon webbing design is fully adjustable
- Metal snap hook at each end for attachment to most weapon systems, brackets, buckles or webbing
- Adjustable design to fit all operators
- Side-release buckle for quick firearm attachment and removal
- Secure three-point cop-lock buckle in the middle for easy weapon removal from attaching point on vest



PART NUMBER	DESCRIPTION	COLOR	MSRP	NSN
70GS13BK	Tactical Releasable S.T.R.I.K.E.® Sling	Black	\$33.95	1095-01-554-0505



UNIVERSAL TACTICAL 1.25" SLING

- Fully-adjustable and ambidextrous two-point design

PART NUMBER	DESCRIPTION	COLOR	MSRP
70UT00BK	Universal Tactical Sling - (1.25")	Black	\$11.45



SHOTGUN SHELL SLING

- Adjustable two-point design constructed of high-quality 2" wide nylon webbing
- Elastic strap holds 15 extra shells
- Attaches to standard sling swivels with durable steel spring hooks

PART NUMBER	DESCRIPTION	COLOR	MSRP	NSN
43SS15BK	Shotgun Shell Sling	Black	\$22.45	1398-01-520-7279



ACCESSORIES

LONG GUN ACCESSORIES



CQD® MARK III™ STEALTH WEAPONS CATCH

- Ultra-quiet with no hook & loop or snaps
- Robust spring-steel catch guarantees years of reliable performance
- Ambidextrous design
- Adjustable, removable elastic weapon retention strap
- Secures shotguns, rifles, less-than-lethal weapons and manual entry tools
- Includes two Speed Clips™ for S.T.R.I.K.E.® webbing attachment and two metal ALICE Clips for belt mounting

PART NUMBER	DESCRIPTION	COLOR	MSRP
71WC00BK	CQD® Mark III Stealth Weapons Catch	Black	\$35.95
71WC00CT	CQD® Mark III Stealth Weapons Catch	Coyote Tan	\$35.95



SHOTGUN BANDOLEER

- Constructed of high-quality 2.25" military belt nylon webbing and heavy-duty 1.5" elastic
- Holds 55 shotgun shells securely

PART NUMBER	DESCRIPTION	COLOR	MSRP
43SB55BK	Shotgun Bandoleer	Black	\$31.45



CQD® MARK II™ WEAPONS CATCHES

- Secure rifles, shotguns, sub-machine guns, tear gas launchers, non-lethal weapons and entry tools
- Offers a quick catch for moderate activity or quick response and a retention catch
- Adjustable retaining strap for various weapons
- Ambidextrous and compact (one size fits all)
- Compatible with existing equipment systems
- Version includes polymer hook for fast clip action and silent operation

PART NUMBER	DESCRIPTION	COLOR	MSRP	NSN
71CQD2BK	CQD® Mark II Weapons Catch	Black	\$45.95	8465-01-491-4509



BUTTSTOCK SHOTGUN SHELL POUCH

- Fully ambidextrous design
- Constructed of lightweight nylon ripstop (pouch and lid)
- Shells are secured by elastic and protected by pouch and cover flap with hook & loop closure
- Holds five 2.25" or 3" shells
- Dual holding points for security

PART NUMBER	DESCRIPTION	COLOR	MSRP
52BS02BK	Buttstock Shotgun Shell Pouch	Black	\$27.45





M4 COLLAPSIBLE STOCK MAG POUCH

- Constructed of lightweight nylon ripstop
- Fits most collapsible stock designs
- Adjustable lid for 20- or 30-round magazines

PART NUMBER	DESCRIPTION	COLOR	MSRP	NSN
52BS17BK	M4 Collapsible Stock Mag Pouch	Black	\$25.45	8465-01-514-8975



BUTTSTOCK MAGAZINE POUCH

- Constructed of lightweight 500 denier ripstop
- Compatible with all standard fixed buttstocks, most rifle magazines and most collapsible stock designs
- Adjustable lid accommodates 20-round or 30-round magazines
- Elastic forward-slip protection strap on back
- Adjustable straps for secure hold

PART NUMBER	DESCRIPTION	COLOR	MSRP	NSN
52BS16BK	Buttstock Magazine Pouch	Black	\$26.45	8465-01-514-8974



TACTICAL CHEEK PAD

- Non-slip material for positive cheek weld
- Height-adjustable inserts
- Adjustable straps with end retaining strap to prevent forward slip

PART NUMBER	DESCRIPTION	COLOR	MSRP
90CP01BK	Tactical Cheek Pad	Black	\$30.45



RIFLE CHEEK PAD

- Constructed of 1000 denier nylon and closed-cell foam
- Aids eye relief efficiency, prevents slipping and reduces recoil to neck and cheek
- Adjustable tie-down system fits most rifle stocks
- Patent D490494

PART NUMBER	DESCRIPTION	COLOR	MSRP	NSN
90CP00BK	Rifle Cheek Pad	Black	\$20.45	1005-01-517-7052



AMMO CHEEK PAD

- Constructed of 1000 denier nylon
- Non-slip material for positive cheek weld
- Allows for quick reload and instant visual of ammo status
- Zippered utility pouch and external ammunition storage

PART NUMBER	DESCRIPTION	COLOR	MSRP	NSN
90CP02BK	Ammo Cheek Pad	Black	\$35.95	1005-01-517-7051



URBAN WARFARE IVS™ PERFORMANCE VENTILATING CHEEK PAD

- IVS™ compression-molded technology for enhanced performance
- Optimizes cheek weld, eye relief and ventilation for extended use
- Raises comb height for improved alignment with large tactical scopes
- Zippered utility pouch and external ammunition storage

PART NUMBER	DESCRIPTION	COLOR	MSRP
90CP05BK	Urban Warfare IVS™ Performance Ventilating Cheek Pad	Black	\$45.95
90CP05CT	Urban Warfare IVS™ Performance Ventilating Cheek Pad	Coyote Tan	\$45.95



BUTTSTOCK SHELL HOLDER (OPEN)

- Open style elastic sleeve slips over rifle or shotgun stock for quick ammo access
- Sewn-on elastic loops keep ammo in place
- Rifle model includes nine ammo loops
- Shotgun model includes five ammo loops

PART NUMBER	DESCRIPTION	COLOR	MSRP
74SH00BK	Rifle Buttstock Shell Holder	Black	\$11.45



ACCESSORIES

ON-GUN COMPONENTS



KNOXX® AXIOM™ R/F RUGER® 10/22® RIFLE STOCK

- Designed specifically for Ruger 10/22 rifles
- Includes all standard Knox® rifle stock features
- No recoil-compensation systems
- Rapid-adjust, six-position stock to fit all shooters (9.75" to 13.5" length-of-pull)
- Compatible with bipods

PART NUMBER	DESCRIPTION	COLOR	MSRP
K98200-C	Knox® Axiom™ R/F Ruger® 10/22® Rifle Stock	Black	\$91.95
K98202-C	Knox® Axiom™ R/F Ruger® 10/22® Rifle Stock	Coyote Tan	\$91.95



KNOXX® SPECOPS STOCK GEN III™

- Reduces felt recoil by up to 80 percent
- Adjusts to six different positions to adapt to any shooter
- Buttstock tensioner removes rattle
- Multiple ambidextrous sling mounting locations
- Easy installation
- US patent 9927206

PART NUMBER	DESCRIPTION	COLOR	MSRP
K35001-C	Knox® SpecOps Stock GEN III™ - Mossberg® 500™	Black	\$171.45
K38701-C	Knox® SpecOps Stock GEN III™ - Remington® 870™	Black	\$171.45



KNOXX® AXIOM A-FRAME™ CARBINE STOCK

- Proprietary butt pad offers smooth shooting experience
- Portable multiple integrated QD Sling Mount for quick, easy sling attachment
- Customizable forward LOP adjustment cam and integrated fit, adjustment screw for custom setup

PART NUMBER	DESCRIPTION	COLOR	MSRP
KAR001BK	Knox® Axiom A-Frame™ Carbine Stock - Commercial	Black	\$59.95
KAR011BK	Knox® Axiom A-Frame™ Carbine Stock - Milspec	Black	\$59.95
KAR011DK	Knox® Axiom A-Frame™ Carbine Stock - Milspec	Dark Earth	\$59.95







KNOXX® BREACHERS GRIP™ GEN III (SHOTGUN)

- Recoil reduction, Patented Recoil Reducing Technology mitigates recoil on heavy shotgun loads
- Ergonomic comfort and control in any environment
- Integrated push-button sling mount
- Shotgun and Sling not included

PART NUMBER	DESCRIPTION	COLOR	MSRP
K35002-C	Knoxx® Breachers Grip™ GEN III - Mossberg® 500™	Black	\$88.95
K38702-C	Knoxx® Breachers Grip™ GEN III - Remington® 870™	Black	\$88.95



KNOXX® AR PISTOL GRIP

- Better ergonomics, improved grip angle and palm swell offer a natural, intuitive feel
- Tactile textured gripping surface for maximum stability in any environment
- Improved trigger guard geometry, protecting middle finger from irritation at base of trigger guard

PART NUMBER	DESCRIPTION	COLOR	MSRP
KARPG1BK	Knox® AR Pistol Grip	Black	\$17.95





RAIL MOUNT VERTICAL GRIP

- Molded of high-performance, fiberglass-reinforced polymer
- Redundant clamp screws for secure, reliable mounting and an adjustable fit for out-of-spec rails
- Two different caps (included) for custom length
- O-ring sealed compartment for tools, batteries, etc.
- 3" length and 3.0oz weight for short grip, 4.5" length and 4.1oz weight for long grip

PART NUMBER	DESCRIPTION	COLOR	MSRP
71VG00BK	Rail Mount Vertical Grip	Black	\$39.95





OFFSET FLASHLIGHT RAIL MOUNT

- Constructed of 6061 T6 aluminum with Type-III hard-coat anodized finish
- For mounting flashlights to Picatinny spec rails
- Offset design for optimal positioning
- Compatible with 1" body flashlights
- Weighs 1.5oz

PART NUMBER	DESCRIPTION	COLOR	MSRP
71RM01BK	Offset Flashlight Rail Mount	Black	\$36.45



RAIL MOUNTED THUMB REST

- Provides a reference point on forend for consistent grip
- Improves weapon manipulation and control
- Enhances function of other accessories such as vertical grips
- Can be inverted to provide both high and low grip options
- Symmetrical design for ambidextrous use
- Constructed of high-performance fiberglass glass-reinforced polymer
- Fits Picatinny style rails
- Sold individually only

PART NUMBER	DESCRIPTION	COLOR	MSRP
71RM00BK	Rail Mount Thumb Rest	Black	\$20.45



AR-15 OVERSIZED TRIGGER GUARD

- Drop-in replacement enlarged to allow better access to the trigger
- Constructed of 6061-T6 aluminum with matte Type-III hard-coat anodized finish
- Designed to accommodate shooters wearing gloves

PART NUMBER	DESCRIPTION	COLOR	MSRP
71TG01BK	AR-15 Oversized Trigger Guard	Black	\$11.45



KNOXX AR HANDGUARD

- Constructed of heat resistant glass reinforced polymer
- Slim, ergonomic profile offers superior comfort and control
- QD sling mount and ambidextrous mounting points fit a variety of sling choices
- Integrated aluminum shield deflects heat away from shooter's hand
- Lightweight polymer construction is textured to promote positive grip, withstands bumps and bruises
- M-Lok mounting surfaces at 3,6 & 9 O'Clock positions.

PART NUMBER	DESCRIPTION	COLOR	MSRP
KARHG2BK	Knox® AR Handguard - Midlength	Black	\$39.95
KARHG1BK	Knox® AR Handguard - Carbine	Black	\$39.95



HYBRID FOLDING SIGHT

- Hybrid construction features solid metal alloy core with advanced co-polymer jacket that eliminates excess bulk.
- Flips up with a gloved hand, holds tight under .308 recoil.
- Tool-less windage and elevation adjustment dials and steel A2 front sight post aid accurate shot placement.
- Rear sight aligns to the M4/AR15 A-frame front sight height.

PART NUMBER	DESCRIPTION	COLOR	MSRP
71BU03BK	Hybrid Folding Sight - Front	Black	\$59.95
71BU04BK	Hybrid Folding Sight - Rear	Black	\$69.95
71BU05BK	Hybrid Folding Sight - Pair	Black	\$119.95
71BU05DK	Hybrid Folding Sight - Pair	Dark Earth	\$119.95



SPORTSTER BIPOD PICATINNY RAIL ADAPTER

- Allows users to attach a bipod to any firearm with a Picatinny rail
- Easy to attach and detach

PART NUMBER	DESCRIPTION	COLOR	MSRP
71RA01BK	Sportster® Bipod Picatinny Rail Adapter	Black	\$16.45

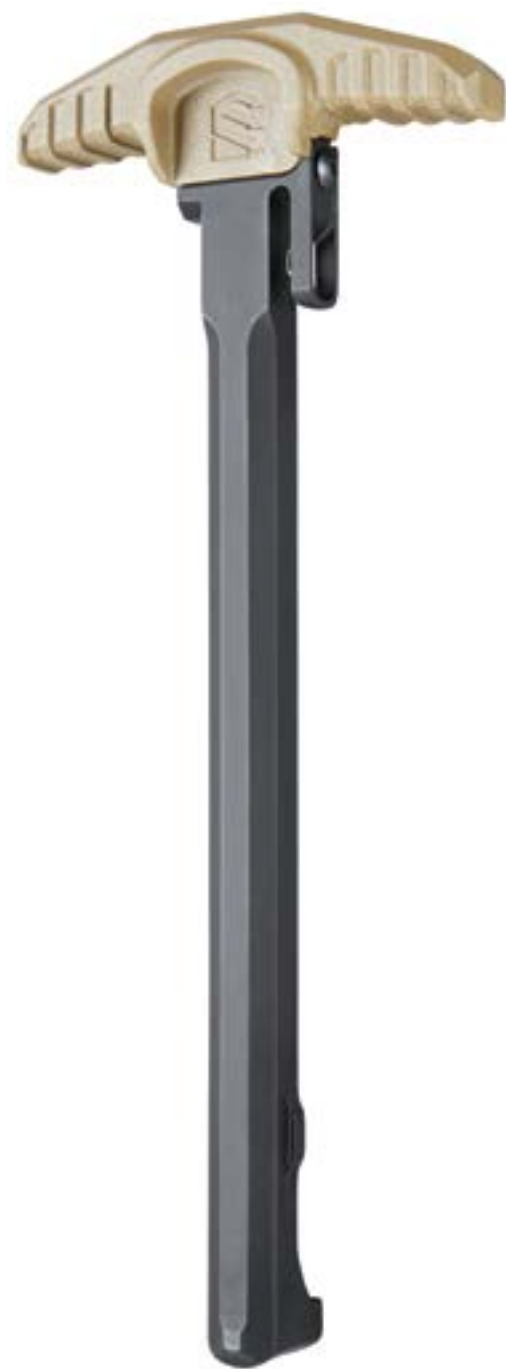

AR-15 NO-LATCH CHARGING HANDLE

- Latch-less design improves reliability, ambidextrous manipulation and shooting performance
- Molded oversize handle offers smooth operation, even while wearing gloves
- Light, strong machined 7075-Aluminum frame and over-molded polymer handle for optimal strength-to-weight ratio

PART NUMBER	DESCRIPTION	COLOR	MSRP
71CH00BK	AR-15 No-Latch Charging Handle	Black	\$47.45
71CH00DK	AR-15 No-Latch Charging Handle	Dark Earth	\$47.45





HEAVY DUTY PUSH BUTTON SLING SWIVEL

- Constructed of quality materials with durable manganese phosphate finish
- Allows operator to quickly attach/detach sling from the weapon
- Compatible with most push-button swivel mounting points

PART NUMBER	DESCRIPTION	COLOR	MSRP
71SS00BK	Heavy Duty Push Button Sling Swivel	Black	\$17.95



OFFSET RAIL ADAPTER

- Mounts on Picatinny-spec rails
- Integrated side rail for small red-dot scopes, lights or lasers
- Allows fast transition between magnified and reflex-style optics

PART NUMBER	DESCRIPTION	COLOR	MSRP
71MT04BK	Offset Rail Adapter - Picatinny	Black	\$36.45



EXTENDED MULTISLOT PICATINNY BASE

- Made of strong aircraft-grade 6061-T6 aluminum and Type III hard-coat anodized
- Picatinny-spec slots compatible with both Weaver and Picatinny rings
- Added 1" of forward length for more mounting options
- Made in USA

PART NUMBER	DESCRIPTION	GUN FIT	MOA	MSRP
71EB00BK	Extended Multislot Picatinny Base	Remington® 700™ - Long Action	0 MOA	\$45.95
71EB01BK	Extended Multislot Picatinny Base	Remington® 700™ - Long Action	20 MOA	\$45.95
71EB02BK	Extended Multislot Picatinny Base	Remington® 700™ - Short Action	0 MOA	\$45.95
71EB10BK	Extended Multislot Picatinny Base	Savage Accu-Trigger - Short Action	0 MOA	\$45.95
71EB11BK	Extended Multislot Picatinny Base	Savage Accu-Trigger - Short Action	20 MOA	\$45.95



ACCESSORIES

SHOOTING SUPPORT & KNIVES



SPORTSTER™ BIPOD

- Compact and lightweight design
- No-rust anodized legs with increased spring tension
- Spring-return telescoping legs
- Unshakable prone and bench shooting
- Easily attaches to sling swivel

PART NUMBER	DESCRIPTION	SIZE	COLOR	MSRP
71BP03BK	Sportster® Bipod	6"-9"	Black	\$50.95
71BP02BK	Sportster® Bipod	9"-13"	Black	\$50.95



SPORTSTER™ TRAVERSETRACK™ BIPOD

- Durable all-metal construction with robust tubular legs
- Horizontal traverse for smooth target acquisition and tracking
- Pivot action for level shooting on uneven terrain
- Rapid-adjust lever lock
- Spring-return telescoping legs
- Easily attaches to sling swivel stud

PART NUMBER	DESCRIPTION	SIZE	COLOR	MSRP
71BP09BK	Sportster® TraverseTrack™ Bipod	6"-9"	Black	\$76.95
71BP16BK	Sportster® TraverseTrack™ Bipod	14.5"-29.25"	Black	\$86.95



SPORTSTER™ PIVOT BIPOD

- Compact and lightweight design
- Pivot eliminates rifle canting on uneven terrain
- Rapid-adjust pivot lever
- No-rust anodized legs with increased spring tension
- Spring-return telescoping legs
- Unshakable prone and bench shooting
- Easily attaches to sling swivel

PART NUMBER	DESCRIPTION	SIZE	COLOR	MSRP
71BP07BK	Sportster® Pivot Bipod	13.5"-23"	Black	\$71.45

HAWKHOOK™

- Blade locks open via a stout frame-lock mechanism in the handle
- Lanyard hole, glass breaker, wire stripper, bottle opener and flat screwdriver/pry tip
- Recessed seat belt/cord cutter and ambidextrous thumb stud
- Blade length is 2.25"/57mm; Overall length is 5.5"/140mm
- AUS8A stainless steel blade with matte bead-blast finish
- Combination plain/partially serrated edge
- 420J stainless steel handle with textured nylon scale
- Pocket clip for right-side, tip-down carry

PART NUMBER	DESCRIPTION	COLOR	MSRP
15HH11SL	HawkHook™	Silver	\$40.95



CQD™ MARK I™ TYPE E MANUAL FOLDER

- Integrated button-lock, secondary safety, recessed belt/cord cutter and carbide glass breaker
- Blade length is 3.75"/95mm; Overall length is 9.5"/241mm
- AUS8A stainless steel blade with black PVD coating
- Edge is partially serrated
- Injection-molded, reinforced nylon handle with 420J stainless steel liners
- Pocket clip for right- or left-side, tip-down carry
- High-visibility yellow handle available for first responders

PART NUMBER	DESCRIPTION	COLOR	MSRP
15M111BK	CQD™ Mark I™ Type E Manual Folder Serrated	Black	\$102.45





ACCESSORIES MISCELLANEOUS



BLACKHAWK STREAMLIGHT® TLR1-HL

- 1,000 lumens; 283m beam; runs 1.5 hours
- Fits existing light bearing holsters
- IPX7 waterproof to 1m for 30 minutes

PART NUMBER	DESCRIPTION	COLOR	MSRP
75FLTLR1BK	TLR1-HL Weapon Light	Black	\$250.00



BLACKHAWK STREAMLIGHT® TLR-7A FLEX

- 500 lumens; 140m beam; runs 1.5 hours
- Ambidextrous on/off switch
- User enabled strobe function

PART NUMBER	DESCRIPTION	COLOR	MSRP
75FLTLR7BK	TLR7A-FLEX Weapon Light	Black	\$225.00

LOAD BEARING CARABINERS

- Locking and non-locking variants available
- 7/16" Anodized Aluminum
- D shaped body
- Major Axis Gate Closed: 31 Kn
- Major Axis Gate Open: 9 Kn
- Minor Axis: 9 Kn
- Alloy / Hardness: 7075-T6/RE 103 Min
- Made in the USA

PART NUMBER	DESCRIPTION	COLOR	MSRP
98NC01BK	5.3" x 3.8" Badge Hanger	Black	\$20.95
98LC01BK	Screw-Lock Carabiner	Black	\$29.95



PERSONAL RETENTION LANYARD

- Tubular webbing and internal shock cord
- Five bar tacks on each end secure internal shock cord and create carabiner loops

PART NUMBER	DESCRIPTION	COLOR	MSRP
98NC01BK	Non-Locking Carabiner	Black	\$20.95
98LC01BK	Screw-Lock Carabiner	Black	\$29.95

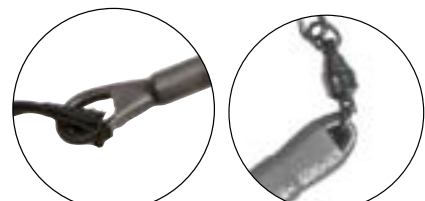

90TPL1BK 90TPL2BK

TACTICAL PISTOL LANYARDS COILED

- Made with coiled wire and black rubber external laminate
- Attaches to belt with loop
- 90TPL1BK attaches to firearm with gutted 550 Cord (not included)
- 90TPL2BK attaches to firearm with snap hook and mini ring

PART NUMBER	DESCRIPTION	COLOR	MSRP	NSN
90TPL1BK	Coiled (Non Swivel)	Black	\$33.45	
90TPL2BK	Coiled (Single Swivel/Snap Hook/Mini Ring)	Black	\$33.45	4020-01-514-8839



ID-BADGE HANGER

- Lid is secured with hook & loop
- Two slip pockets for passport, ID, business cards, money, etc.
- Pen pouch for quick access

PART NUMBER	DESCRIPTION	COLOR	MSRP	NSN
90ID01BK	5.3" x 3.8" Badge Hanger	Black	\$14.45	8455-01-529-5688



RED CROSS MEDIC ID PATCH

- Smooth embroidery (not printed)
- Hook backing with loop panel included
- Can be sewn to clothing or gear
- Dimensions: 2.5"H x 2.5"W

PART NUMBER	DESCRIPTION	COLOR	MSRP
90RC00BK	Red Cross Medic ID Patch	Black	\$7.45



IDENTIFICATION PANEL BASE

- Hook & loop panel for attaching ID panels to S.T.R.I.K.E.® webbing
- Mounts with Speed Clips™ (two included)
- Dimensions: 2.5"H x 5.5"W

PART NUMBER	DESCRIPTION	COLOR	MSRP
38CL42BK	Identification Panel Base	Black	\$10.45



90RWBV Standard Full Color



90SAFV Standard Subdued Olive Drab



90DTFV Standard Subdued Coyote Tan

AMERICAN FLAG PATCH

- Embroidered with matching border
- Hook & loop panel for quick on/off capability
- Dimensions: 2"H x 3"W

PART NUMBER	DESCRIPTION	COLOR	MSRP
90SAFV-R	American Flag Patch-Reversed	Olive Drab	\$7.45
90SAFV	American Flag Patch	Olive Drab	\$7.45
90RWBV-R	American Flag Patch-Reversed	Full Color	\$7.45
90RWBV	American Flag Patch	Full Color	\$7.45
90DTFV-R	American Flag Patch-Reversed	Coyote Tan	\$7.45
90DTFV	American Flag Patch	Coyote Tan	\$7.45
90BHSEOS	BLACKHAWK Logo Patch	Steel	\$7.45
90BHBKOS	BLACKHAWK Logo Patch	Black	\$7.45



BLACKHAWK[®]

2022 CATALOG