

RCBS®

ULTRASONIC CLEANER



PRODUCT INSTRUCTIONS

⚠ WARNING!

Before using this product, read and follow these instructions carefully. Failure to do so could result in serious injury or death, or property damage.

**If you have any questions while assembling or operating this product,
call us at 1-800-533-5000 or 1-530-533-5191
Monday – Thursday 6:30 a.m. – 4:00 p.m. Pacific Time
Or email us at rcbs.tech@atk.com**

This manual contains important safety and operating information. Keep this as a permanent part of your reloading equipment. If lost, contact us for a replacement.

SAFETY PRECAUTIONS

To avoid death or serious injury, observe the following precautions:

⚠ WARNING! Shock hazard.

- Never immerse device in water or other liquid. If the device falls into water, do not touch. Unplug first.
- Never touch the power cord or plug with wet hands.
- Unplug by grabbing the power plug, not the cord.
- Use in GFCI outlets with current-imbalance protection of 30mA or less.
- Protect device from damage. Do not use if any part of the plug, cord, electrical housing or device is damaged. Inspect device regularly.
- Do not disassemble the device or attempt repairs yourself; contact RCBS.
- Turn device off and keep unplugged at all times when not in use.
- Use only in a properly grounded, polarized outlet. Do not remove or alter the grounding prong or use with adaptors.
- Unplug unit before filing or draining.

⚠ WARNING! Keep away from children.

- This device is not intended for use by those with restricted physical, mental or sensory capabilities or those with a lack of experience and/or knowledge, including children.
- Store device out of reach of children.
- Keep device and packaging material away from children.

⚠ CAUTION! Burn hazard

- Do not touch inside of device or liquid during or after operation until cooled.
- Allow device to cool before attempting to clean or service.
- Unplug device before cleaning or if malfunction occurs.
- Always use drain valve to empty tank.

⚠ CAUTION! Fire hazard

- Do not clean or use device with flammable cleaners or other liquids.
- Keep device vents free from lint, dust, hair and other obstructions.
- Use device on clean, flat, dry, hard surface.
- Keep device unplugged when not in use.
- Never operate the device unattended.
- Do not operate device without water or with water below the Min. line.

⚠ CAUTION! Misuse can corrode or degrade condition of case or ammunition, and create a dangerous condition.

- Never use chemicals in device unless recommended in this manual.
- Allow cleaned cases to fully air dry before loading. Never dry in an oven, as doing so can dangerously weaken the case.
- Do not use this device to clean loaded ammunition or primed cases. Doing so can dampen propellant and/or primer mix, and result in misfire or hangfire.

NOTICE – Avoid damage to your device:

- Do not place parts/materials to be cleaned directly into the device without the basket. Doing so can damage the steel tank.
- Do not turn on or plug in device before filling with water.
- If device has been in operation for 45 minutes, turn off for 10 minutes before next use.
- Do not fill tank above the Max line.
- Do not use solutions containing abrasive or corrosive substances. Use only solutions recommended by RCBS.
- If device is subjected to severe electromagnetic interference, it may malfunction, stop operating or lose control functions. If this happens, unplug the cord and plug it back in to restart the device.

RELOADING SAFETY

NOTICE - This manual is not intended to provide comprehensive instructions or safety information on how to reload, or handle or use reloading components. Always read and thoroughly understand a reloading manual before attempting to reload ammunition.

Reloading is an enjoyable and rewarding hobby when conducted safely. But, as with many hobbies, carelessness or negligence can make reloading hazardous. When reloading, always follow these safety guidelines to minimize the risk of personal injury or death.

- Always wear safety glasses.
- Understand what you are doing and why. Read handbooks and manuals on reloading. Talk to experienced reloaders. Write or call suppliers of equipment or components if you have questions or are in doubt.
- Read and understand all warnings and instructions accompanying your equipment and components.
- Don't rush or take short cuts. Establish a routine and follow it at a leisurely pace.
- Keep complete records of reloads. Label each box showing the date produced, caliber and the type of primer, powder and bullet used.
- Do not smoke while reloading, or reload near sources of heat, sparks or flame.
- Observe good housekeeping in the reloading area. Keep tools and components neat, clean and orderly. Promptly and completely clean up any spills.
- Keep all reloading equipment and components out of reach of children.
- Stay alert. Reload only when you can give your undivided attention. Do not reload when tired, ill, rushed or under the influence of drugs or alcohol.

WORKING WITH CARTRIDGES CASES

- Examine empty cases to be sure they are in good condition before reloading. Thin, split, deformed or badly corroded or pitted cases may be structurally weak, and result in a dangerous condition.
- Do not store cartridge cases or ammunition near harsh chemicals such as gasoline, household cleaners, or cat urine. The fumes can weaken the metal and present a dangerous condition.
- Do not clean cases with chemicals other than those specifically designed for this purpose.
- Ensure cases have proper primer pocket sizes; remove primer staking/crimp if necessary. Attempting to seat a primer into an undersized pocket or pocket with staking/crimping can result in detonation.
- Resize and trim fired cases to ensure reliable chambering and obtain proper bullet tension and crimp.

Because RCBS has no control over the choice, assembly or use of components or other reloading equipment, RCBS assumes no liability, express or implied, for the use of ammunition reloaded with this product.

RCBS LIMITED WARRANTY

Your RCBS case cleaner is warranted to be free from defects in material or workmanship for one (1) year from the date of purchase. This warranty is extended only to the original consumer purchaser. All RCBS products are intended for non-commercial use by hobbyists. Any other use of these products will void the warranty. If you believe that your product is covered by this warranty, you must return the product to RCBS at the address below, postage paid, with proof of purchase for evaluation. If covered, we will (at or sole option) repair, replace or refund the purchase price of any part or product found to be defective. This remedy will be without charge except for reasonable shipping, handling and insurance charges. TO ENSURE ACCURACY OF YOUR WARRANTY INFORMATION, SEND YOUR DATED PROOF OF PURCHASE TO THE ADDRESS BELOW.

This limited warranty does not cover defects or damage resulting from carelessness, misuse, commercial use, abuse, neglect, improper installation or assembly, water submersion, unauthorized or improper repair, failure to follow operation instructions, modification or normal wear and tear.

ANY WARRANTIES IMPLIED BY LAW SHALL IN NO EVENT EXTEND BEYOND DURATION OF THIS EXPRESS WARRANTY. Some States do not allow limitations on how long an implied warranty lasts, so the above limitation may not apply to you. REPAIR OR REPLACEMENT AS PROVIDED HEREIN IS YOUR EXCLUSIVE REMEDY FOR ANY DEFECTIVE PRODUCT. IN NO EVENT SHALL WE BE LIABLE FOR ANY SPECIAL, INCIDENTAL OR CONSEQUENTIAL DAMAGES OF ANY KIND ARISING OUT OF THE PURCHASE OR USE OF THIS PRODUCT, WHETHER BASED UPON CONTRACT, TORT, STATUTE OR OTHERWISE. Some states do not allow the exclusion or limitation of incidental or consequential damages, so the above limitation or exclusion may not apply to you. This warranty gives you specific legal rights, and you may also have other rights which vary from State to State.

CONTACT US

RCBS
605 Oro Dam Blvd, Oroville, California 95965
1-800-533-5000
Email: rcbs.tech@atk.com

ULTRASONIC CLEANING

The RCBS Ultrasonic Cleaner is designed to clean metallic surfaces. Ultrasonic cleaners work by creating millions of tiny air bubbles inside the liquid by high frequency vibration. The air bubbles burst inside the liquid on the surface of the submerged items and shake off the debris to achieve the cleaning effect. When used with the RCBS Ultrasonic Case Cleaning Solution, your cases will be clean and free of carbon fouling, lubricants, and debris on the exterior and interior, of your cartridge cases. Purified or distilled water has the same cleaning effect as regular tap water for ultrasonic cleaning. Therefore using tap water is sufficient. However, your tap water may contain minerals and solids which may cause spots on surfaces. When cleaning silver or copper items where oxidation and carbon fouling has darkened the items, special cleaning solutions such as RCBS Ultrasonic Case Cleaning Solution needs to be added to the water to remove the oxidation. The RCBS Ultrasonic Cleaner comes equipped with a special degassing function. When cleaning solutions are added to the water in the tank, droplets of solution will form which take time to dissolve in the water. The solution may also form many small air bubbles on the tank walls. The droplets and bubbles act as a buffer or insulator which may reduce the cleaning effectiveness. The degassing function will aid in dissipating the bubbles and droplets, which will improve the cleaning efficiency. The degas function will operate for 2 minutes, which is generally enough time to dissipate the droplets and bubbles.

To order the RCBS Ultrasonic Case Cleaning Solution or find out more information, contact RCBS or visit our website (www.rcbs.com).

MAIN FEATURES

- Tank size: 9.8"x6.9"x3.1" / 25.0x17.4x7.8 cm
- Tank capacity: 3.2 qt./ 3 L
- Longest item that can fit inside the tank is 10.47" / 26.6 cm.
- 3-color LED display.
- 1 to 30-minute full range timer
- 5 pre-set temperature settings. Temperature display in °C or °F. Ceramic heater and overheat protector
- Solution usage timer (Solution time remains in memory even when electricity is switched off).
- Industrial grade ultrasonic transducer.
- Industrial grade IC.
- Moisture-proofed PCB with cooling fan.
- Drainage valve.

USES

- Cartridge Cases – Using specialized cleaning solutions specifically for cartridge cases; such as the RCBS Ultrasonic Case Cleaning Solution.
- Gun Parts – Using specialized cleaning solutions.
- Jewelry – Using water only.
- Eye Glass frames – Using water only.
- Tools – Using specialized cleaning solutions

UNPACKING

Refer to the list below to identify parts as you carefully unpack your new Ultrasonic Cleaner:

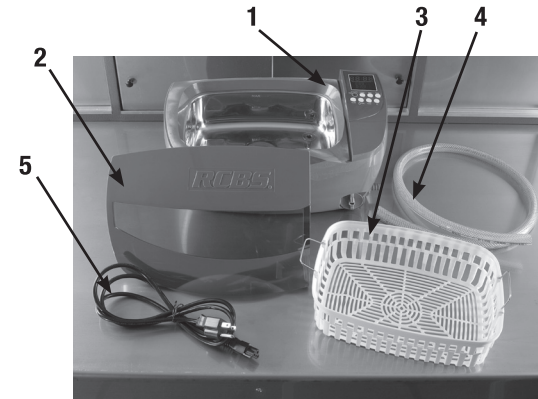

ITEM #	DESCRIPTION	PART #
1	Ultrasonic Cleaner	
2	Lid	7187095
3	Plastic Basket	7187098
4	Drain Hose	7187097
5	Power Cord	7187099

DISPLAY



1. **Digital Timer Display** - Displays the set run time.
2. **Water Temperature Indicator** - Solid green light indicates that the water temperature is 0-30% of the set temperature. Solid orange light indicates that the water temperature is 30-60% of the set temperature. Solid red light indicates that the water temperature is 60-90% of the set temperature. Flashing red light indicates that the water temperature is close to the set temperature. All solid lights indicate that the water temperature is at the set temperature (90-100%).
3. **Set Temperature Display** - Display will show one of the 5 pre-set temperatures. 40 ⇨ 104°F, 45 ⇨ 113°F, 50 ⇨ 122°F, 55 ⇨ 131°F and 60 ⇨ 140°F
4. **Set Temperature Units Indicator** - Indicates if temperature is either °C or °F.
5. **Solution Timer** – Counts down to show remaining solution usage (Hour:Min).
6. **Solution Set Indicator** - When is flashing solution needs to be changed and timer needs to be reset. When is displayed, solution timer is set and timer will begin counting down when Ultrasonic Cleaner is in operation.
7. **Degas Status** - When is displayed, unit is in degassing mode.
8. **Heater Status** – When is illuminated heater is turned on. If is not illuminated, the heater is turned off.
9. **Normal Cleaning Status** – When is illuminated, normal cleaning is underway.
10. **Indicator Lights** - Working status
Green – Ready: Green light indicates normal working status, ready to use.
Red – Overheat (R): Red light indicates overheat protection. 20 minutes or more time required for the light to change from red to green. When light is green normal operation may resume.

KEYPAD

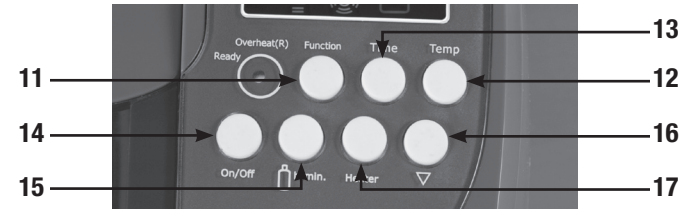

11. **Function Button - Functions (Degas/Normal).** Depressing function button will illuminate, indicating degassing function is desired. Depressing function button again will illuminate indicating normal ultrasonic cleaning. Pressing On/Off button will begin cleaning. If unit is in degassing mode, will flash for 2 minutes while unit is degassing. After 2 minutes has elapsed, will illuminate, indicating normal ultrasonic cleaning has begun and degassing has stopped. If more degassing is required depress function button and will illuminate indicating degassing is underway.
12. **Temp Button - Temperature set button.** 5 pre-set temperatures can be selected. Press Temp button to select the temperature in the following sequence: 40 ⇨ 104°F, 45 ⇨ 113°F, 50 ⇨ 122°F, 55 ⇨ 131°F and 60 ⇨ 140°F. The temperatures are pre-set and will display temperature in °C first then °F.
13. **Time Button - Timer quick set button.** Press Time button, LED will display run time. When time button is depressed, time will increase by 5 minutes up to a maximum run time of 30 minutes.
14. **On/Off Button - On/off switch.** When unit is plugged in and the unit is powered on the LED will display, the default 05:00 minutes run time and the unit is ready to operate in the normal ultrasonic cleaning mode for 5 minutes. Press the On/Off button once to initiate cleaning. The cleaning will stop when the timer counts down to 00:00. If the unit needs to be Stopped, before the timer runs out, press the On/Off button to turn off ultrasonic cleaning.
15. **h/min - Solution Timer Set Button.** Each time is depressed; the timer is increased by 20 min. The maximum time that can be set is 9 hr 60 min. When flashes solution needs to be changed. Depressing button will reset timer.
16. **▽ Button - Decreasing Button.** When Time is used, each pressing reduces the timer by 1 minute. When Temp is used, each pressing reduces the set temperature down to the next level. When h/min is used, each pressing reduces the solution set time by 20 minutes.
17. **Heater Button — Heater On/Off Button.** Pressing Heater button will flash indicating heater is turned on. To cancel heating, press Heater button again and will dim, indicating heater has been turned off. When water reaches the set temperature the heater will turn off automatically.

NOTE: There is an overheat safety feature built into the RCBS Ultrasonic Cleaner, which will automatically shut off heater after it has been in operation for 90 minutes, regardless if the water temperature has reached the pre-set temperature. If using cold tap water and trying to heat up to 60°C ⇨ 140°F, the overheat safety will automatically shut the heater off before desired temperature is reached. If this happens simply depress the heater button again to turn heater on. Using warmer water will aid in reducing the amount of time needed to bring water to desired temperature.

OPERATING INSTRUCTIONS

1. Ensure Drain Valve is in closed position by rotating valve in CCW direction as shown in Photo 2.

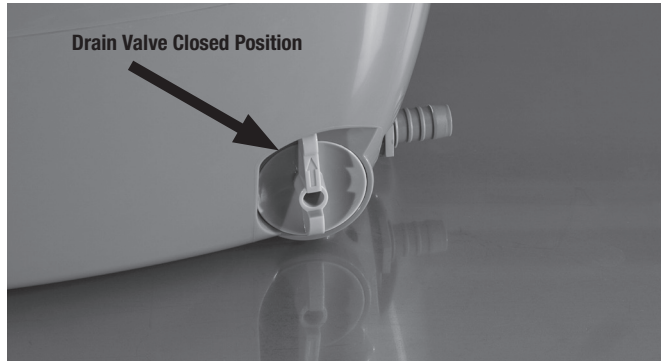

Photo 2

2. Place items in basket to level shown in Photo 3. Note: this is the maximum fill line on the basket to ensure water completely covers items in basket and is not above Max fluid fill line shown in Photo 4.



Photo 3

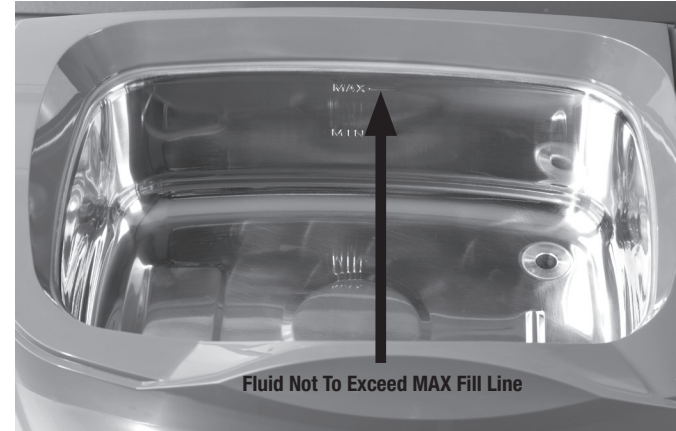

Photo 4

3. Pour water or cleaning solution into reservoir and ensure fluid level is not above level shown in Photo 4.

Note: With basket filled and placed in reservoir containing fluid, ensure fluid level does not exceed level shown in Photo 5.



Photo 5

4. Insert Power Cord into socket located in the back of the RCBS Ultrasonic Cleaning Unit. See Photo 6

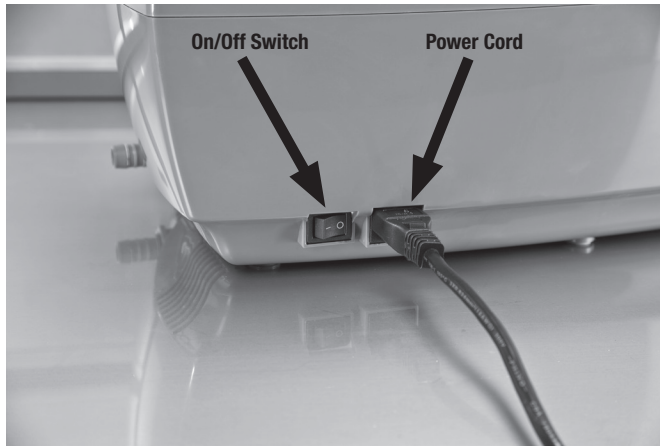

Photo 6

5. Plug opposite end of Power Cord into a grounded 120VAC wall socket.
6. Turn the On/Off switch to the On position, see Photo 7.

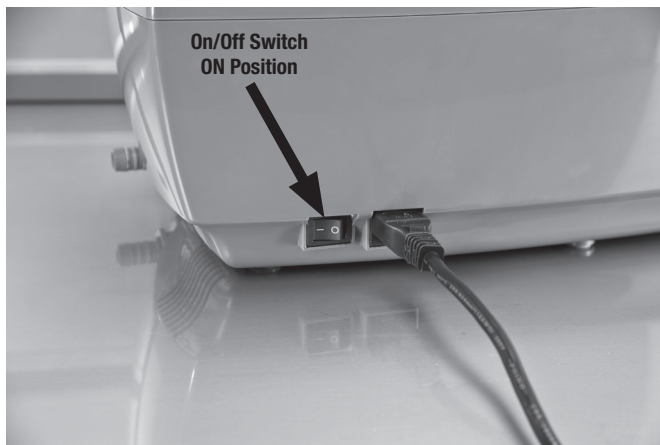

Photo 7

7. Set temperature by depressing Temp Button until desired temperature is displayed.
8. When fluid reaches desired temperature, slowly place loaded basket into Ultrasonic Cleaning Unit.
9. Place lid securely onto Ultrasonic Cleaning Unit.

10. Set time by depressing Time Button until desired time is displayed.
11. If Degassing is desired, depress Function Button until the ☐ symbol is displayed.
12. If Degassing is not desired, the (C) symbol will be displayed specifying normal cleaning operation.
13. Ensure the Green ready light is illuminated.
14. Depress the On/Off button to initiate cleaning. You will hear a buzzing sound indicating the Ultrasonic Cleaner has begun the cleaning cycle.
15. If the degassing function is being used, the unit will cycle on and off for 2 minutes until the degassing operation is completed, at which time the (C) symbol will automatically display and normal cleaning operation will begin
16. Once the Ultrasonic Cleaner has been in operation for the desired time the unit will automatically shut off.
17. When cleaning has been completed, turn off the Power Switch, located in the back of the unit, see Photo 6.
18. Unplug Power Cord from socket on back of unit.
19. Remove the lid and remove basket from Ultrasonic Cleaner.
20. Place basket inside another container containing rinse water. Agitate items in rinse water and continue to rinse until all cleaning solution has been rinsed from items. Be sure to discard rinse water and cleaning solution according to cleaning solution manufacturers recommendations and local disposal regulations.
21. Place cleaned and rinsed items onto a clean, dry surface. Spread items out and allow to dry. Drying time can be reduced by using a hair dryer, or placing in direct sunlight.
22. If more cleaning is necessary repeat steps 4 through 16 mentioned above. If cleaning solution is dark and murky it will need to be replaced. If cleaning is completed proceed to step 23.
23. Attach drain hose to drain or place a 3L / 3.17Qt. reservoir below drain. Rotate Drain Valve CW 90 degrees to begin draining fluid from tank, see Photo 8.

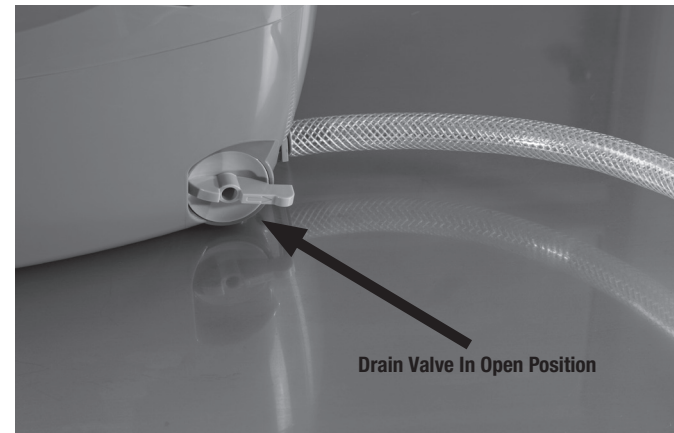

Photo 8

24. When tank has been completely drained, rinse tank with clean water, rotate Drain Valve CCW 90 degrees to close drain, as shown in Photo 2.
25. Wipe tank and other areas of cleaner with a clean dry cloth to remove any excess moisture accumulated during use.
26. Store unit in dry, cool ventilated area.

HELPFUL HINTS

1. Deprime all cartridge cases prior to cleaning to allow for adequate cleaning of the primer pockets.
2. If cleaning cartridge brass with the spent primers left in the brass, deprime immediately in order to prevent corrosion caused from the wet spent primer. If this is not done corrosion may occur which could potentially damage or weaken the case.
3. During operation cleaning effectiveness is enhanced by agitating the items to be cleaned. Midway through cleaning cycle, simply remove the lid and grasp basket by the handles lift basket and agitate items contained within basket. This orients items in a different position allowing the ultrasonic cleaning action to work on different areas of the items to be cleaned.
4. Parts to be cleaned should be free of excessive oil.
5. Using distilled or de-ionized water will reduce mineral deposit residue on items.
6. Cleaning effectiveness of the cleaning solution used will degrade after each use. If items are heavily soiled and many items are being cleaned with each cycle, the solution may require frequent changing. As the cleaning solution becomes darker, the cleaning effectiveness degrades.
7. Placing articles in basket and allowing space between articles greatly increases the cleaning effectiveness. The more items contained in the basket the longer cleaning time required to clean items.
8. Having a separate container, which will accommodate the plastic basket, makes rinsing cases much more efficient.
9. Using a hair dryer or placing items in direct sunlight will speed drying time.

CARE AND MAINTENANCE

- After each use turn unit off and unplug power cord from unit.
- Drain unit as explained previously.
- Do not leave water or cleaning solution in cleaning tank for extended periods.
- Wipe all excess moisture from unit, with a clean dry cloth, and allow to air dry with the lid off.
- Store in dry, cool ventilated area.

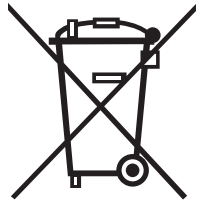

This symbol on the product or on its packaging indicates that this product must not be disposed of with your other household waste. Instead, it is your responsibility to dispose of your waste equipment by handing it over to a designated collection point for the recycling of waste electrical and electronic equipment.

The separate collection and recycling of your waste equipment at the time of disposal will help to conserve natural resources and ensure that it is recycled in a manner that protects human health and the environment. For more information about where you can drop off your waste equipment for recycling, please contact your local city office, your household waste disposal service or the shop where you purchased the product.

SPECIFICATIONS

Description	RCBS Ultrasonic Cleaner (100-120V)	
Model	87055	
Tank Capacity	3000 mL / 3.2 Qt.	Max 2500 mL / 2.6 Qt.
		Min. 1500 mL / 1.6 Qt.
Tank Size	25.0 x 17.4 x 7.8 cm / 9.8" x 6.9" x 3.1"	
Longest Item to Fit in Tank	26.6 cm / 10.47"	
Power	150 W (AC 100~120V 60 Hz)	
Digital Timer	1-30 Minute Timer	
Temperature Settings	40°C/104°F > 45°C/113°F > 50°C/122°F > 55°C/131°F > 60°C/140°F	
Drainage	Drainage Valve	
Ultrasonic Frequency	36,000 Hz	
Tank Material	SUS 304 Stainless Steel	
Housing Material	ABS	
Net Weight	3.6 kg / 8.0 lb.	
Gross Weight	4.1 kg / 9.1 lb.	
Unit Size	38.5 x 23.4 x 19.3 cm / 15.2" x 9.2" x 7.6"	
Inner Box Size	43.0 x 27.5 x 24.5 cm / 16.9" x 10.8" x 9.6"	
QTY Per Master Carton	4 Units	
Master Carton Size	56.5 x 44.0 x 51.0 cm / 22.2" x 17.3" x 20.1"	

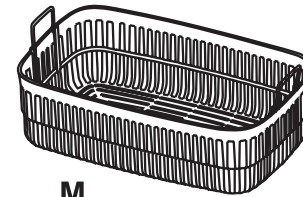
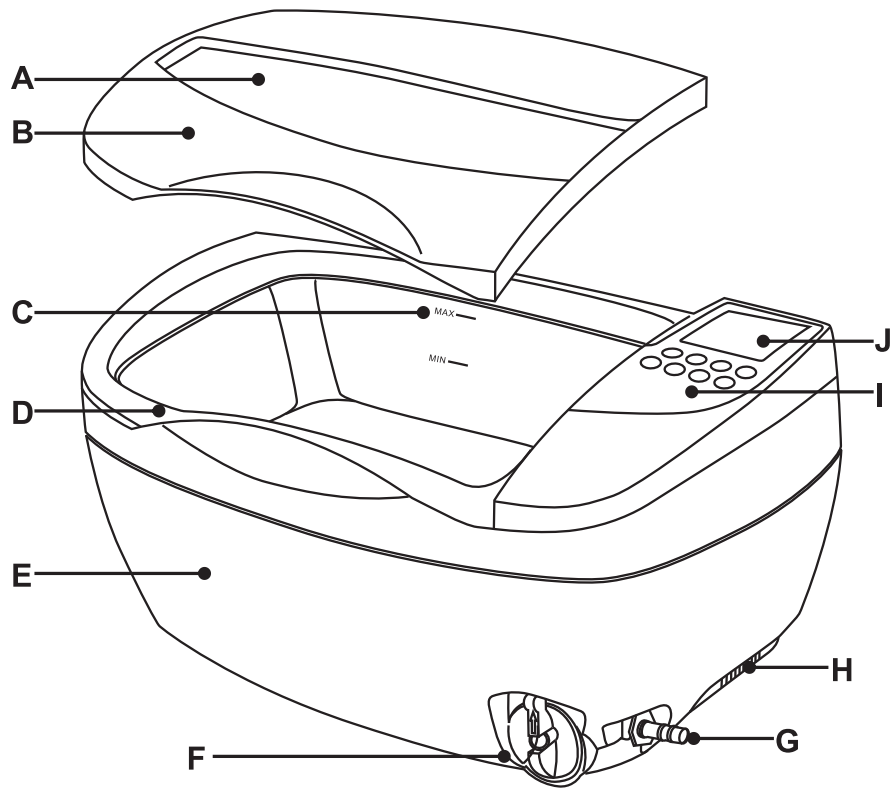

M



K



L

ULTRASONIC CLEANER PARTS

A	Window
B	Lid
C	Stainless Steel Tank
D	Sealing
E	Housing
F	Drainage Valve
G	Drainage Pipe
H	Vent
I	Control Panel
J	Digital Display
K	Hose
L	Power Cord
M	Plastic Basket

RCBS[®]

PRECISIONEERED RELOADING EQUIPMENT

We think that we make the very best reloading equipment in the world.

If you agree, please tell your friends.

If you disagree, tell us we want to do something about it!

Customer Service

1-800-533-5000 (US or Canada) or 530-533-5191

Hours: Monday - Thursday, 6:30 a.m. - 4:00 p.m. Pacific Time
(hours may vary)

e-mail: rcbs.tech@atk.com or visit our website at www.rcbs.com

RCBS 605 Oro Dam Blvd. East Oroville, CA 95965

Federal Premium Ammunition - RCBS - Alliant Powder - CCI
Speer Ammo - Speer Bullets - Fusion Ammunition
Estate Cartridge - Blazer Ammunition - Force on Force
Weaver - BLACKHAWK! - Champion - Gunslick Pro - Outers
Buck Commander - Duck Commander

060712